

On the Status of Empty Nuclei in Phonology

by

Hitomi Onuma

B.A., Tohoku Gakuin University (2007)

M.A., Tohoku Gakuin University (2010)

Dissertation Submitted to the Division of Letters

In partial fulfillment of the requirements for the degree of

Doctor of Philosophy

at the

TOHOKU GAKUIN UNIVERSITY

August 2015

Dissertation Committee:

Professor Kuniya Nasukawa, Chairperson

Professor Phillip Backley

Professor Emeritus Yuichi Endo

Associate Professor Ali Tifrit, University of Nantes, France

Abstract

Syllables containing empty nuclei have been employed in the phonology literature to analyse a variety of phenomena such as vowel-zero alternations and vowel reduction (Kaye, Lowenstamm and Vergnaud 1985, 1990; Kaye 1990ab, 1995; Charette 1991; Harris 1994, 1997; Lowenstamm 1996; Scheer 2004; Nasukawa 2005a; Backley 2011). Whether empty nuclei are phonetically realised or not is determined by p[rosodic]-licensing through devices such as Proper Government and the Domain-final-empty-nucleus Parameter: when an empty nucleus is p-licensed, it is not phonetically realised; on the other hand, when an empty nucleus is not p-licensed, it manifests itself as the default vowel of the language in question – typically a central vowel such as *ə*, *i* or *u*.

However, there are some contentious issues surrounding the status of empty nuclei. First, an empty nucleus which is phonetically realised as *ə* does not form a natural class with non-high vowels in the description of English vowel reduction (non-high vowels typically become *ə* in unstressed positions). Second, it is difficult to establish what kind of mechanism determines whether a word-final empty nucleus is realised as *ə* (e.g., *danə* ‘Dinah’) or is permitted to be silent (e.g., *dan* ‘dine’). Third, in the interests of representational reductionism it is not only the status of empty nuclei but also the status of the nucleus itself which may be called into question, since the properties inherent in a nucleus can be reduced down to other phonological units: (i) *vocalicness* can be represented by vocalic features (e.g., [vocalic], [sonorant]) and (ii) *precedence* can be expressed by timing units such as skeletal positions and Root nodes.

In response to the first and second questions, I follow the line of argument in Backley (2011) and claim that in the framework of Element Theory the vowel ə is represented by a structure consisting of |A| rather than by an empty nucleus, since |A| is the only element which is shared by all non-high vowels. In order to solve the third point of contention, I adopt a precedence-free model of phonological representation (Nasukawa 2011, 2014, 2015ab) which describes phonological structure by referring only to dependency relations between units, thereby eliminating all categories/constituents that are associated with precedence. Within the context of Precedence-free Phonology, I develop representations for the vowels of English and analyse a range of phonological phenomena which will validate the proposed vowel structures.

Acknowledgements

First and foremost, I would like to express my sincerest gratitude to my supervisor, Kuniya Nasukawa, who has consistently supported me throughout the writing of this dissertation, as well as in every other aspect of my studies at Tohoku Gakuin University from my first year through to my last. Without his continuing guidance and patience, I would never have completed this dissertation. I greatly appreciate how he has contributed his time, depth of knowledge and insightful advice to make my research experience stimulating and productive. He always shows an enthusiasm for his research, which has been motivating for me, even during the tougher periods of my Ph.D. program. I feel very fortunate to have had him as my supervisor.

I am deeply grateful to the rest of my dissertation committee: Phillip Backley, Yuichi Endo and Ali Tifrit. Phillip Backley has always been generous to provide me with his time, beneficial suggestions and positive feedback throughout much of the research process for this thesis and related works. Yuichi Endo has given me not only academic support but also an opportunity to secure a teaching job that enabled me to keep my career here. He kindly honored my request for him to be a member of my dissertation committee despite his serious health problems. Ali Tifrit is a world-renowned phonologist and I am honored to have him as the external member of my committee.

Beside the members of my committee, the teaching staff in the Department of English at Tohoku Gakuin University deserve my gratitude and appreciation. I owe great thanks to Masayuki Oishi, who initially led me into generative linguistics. I have learned a great deal from classes and conversations with him. I would also like to thank other members, especially Hitoshi Muranoi, Kenich Endo, Yoshitaka Shibata, Etsuro

Hatakeyama, Yasuo Uemastu, Fumiko Yoshimura, Keith Adams and Osamu Yagawa. They provided me with invaluable lectures and gave me support of various kinds. I am also thankful to the following researchers, John Harris, Teruhiro Hayata, Masayuki Ikeuchi and Hisatsugu Kitahara, for the lectures they gave during intensive courses. They introduced me to the broader aspects of linguistics study on which my research and this thesis have been based on. My gratitude must be extended to Tohoku Gakuin University, which has provided generous financial support for travel and conference expenses.

My special thanks go to my colleagues, past and present, for supporting and encouraging me during my studies. I have enjoyed and appreciated the opportunity to share time with them all. Thanks are due in particular to Nobu Goto, Ken Hatakeyama, Mika Kawauchi, Haruka Li, Yoriko Kimura, Aki Kobayashi, Fumio Miyazawa, Emi Aoki, Ren Oyama and Hiroyuki Nihei.

Finally, I owe a private debt of gratitude to my family. I am grateful to my parents Yuzo and Mieko Onuma, my brother Takaaki Onuma, and my sister Naomi Onuma for their constant support and warm encouragement during my career as a student. My research would never have been possible without their help.

Contents

Abstract	2
Acknowledgements	4
Contents	6
Chapter 1	
Introduction	
1.1. The origin of empty nuclei	11
1.2. The role of empty nuclei	11
1.3. Problems of empty nuclei	12
1.4. The representation of English schwa	13
1.5. English schwa is not the phonetic manifestation of empty nuclei	15
1.6. Replacing empty nuclei by minimal contrastive units	17
1.7. Representing the vowels of English	18
1.8. Sonority	20
1.9. The organisation of this study	21

Chapter 2

Empty categories in phonology

2.1. Introduction	23
2.2. Phonetically-unrealised categories in syntax	25
2.3. Empty categories in phonological studies	26
2.3.1. Empty onsets	26
2.3.2. Empty nuclei	30
2.3.3. Word-final empty nuclei	38
2.3.3.1. Arguments against the final-coda view	38
2.3.3.2. Word-final C as an onset followed by an empty nucleus	42
2.4. The phonetic interpretation of empty nuclei	44
2.4.1. Vowel-zero alternations	44
2.4.2. Epenthetic vowels in the nativisation of loanwords	50
2.5. Schwa as the phonetic interpretation of empty nuclei in English?	59
2.6. Summary	66

Chapter 3

The representation of English Schwa

3.1. Introduction	69
3.2. The representation with emptiness	71
3.2.1. A I U -based models vs. Distinctive Feature Theory	71
3.2.2. Empty structure for vowel representation	74
3.2.2.1. Element Theory (Backley 2011)	74
3.2.2.2. Dependency Phonology (Anderson and Ewen 1987)	81
3.2.2.3. Government Phonology (Kaye, Lowenstamm and Vergnaud 1985)	83
3.2.2.4. Particle Phonology (Schane 2005)	86
3.2.3. Phonological emptiness and its phonetic realisation	88
3.3. Schwa	91
3.3.1. Characterising schwa	91
3.3.2. Distributional patterns of English schwa	93
3.3.3. Alternation between full vowels and schwa	95
3.4. Representing English schwa	101
3.4.1. Vowel reduction	101
3.4.2. Word-final schwa	105
3.4.3. Word-internal schwa	108
3.5. Summary	114

Chapter 4

Representing nuclear expressions in Precedence-free Phonology

4.1. Introduction	116
4.2. Relational properties in phonology: precedence and dependency	117
4.3. Basics of Precedence-free Phonology	124
4.3.1. Elements as basic building blocks for constructing phonological structure	124
4.3.2. A I U as the head of the vowel expression	129
4.4. Representing English vowels	135
4.4.1. Short vowels (<i>ə, ɪ, ʊ, ʌ, e, æ, ɒ</i>)	135
4.4.2. Long vowels (<i>i:, u:, a:, ɔ:, ɜ:</i>)	141
4.4.3. Diphthongs (<i>aɪ, eɪ, ɔɪ, əʊ, əʊ, ɪə, eə</i>)	143
4.5. Vowel reduction in English	147
4.6. Vowel reduction beyond English	153
4.7. Monophthongisation and diphthongisation in English	158
4.8. Linearisation in Precedence-free Phonology	166
4.9. Summary	174

Chapter 5

Conclusion

5.1. Summary	177
5.2. Further remarks	180

Appendix

A. Chomsky and Halle's Distinctive Features	181
B. Components in Dependency Phonology	182
C. Elements	183
D. Phonetic symbols	184
References	185

1 Introduction

1.1. The origin of empty nuclei

In this study I discuss the status of empty nuclei, which have been employed in representational approaches such as Government Phonology (Kaye, Lowenstamm and Vergnaud 1985, 1990; Kaye 1990ab, 1995; Charette 1991), Strict CVCV Phonology (Lowenstamm 1996; Scheer 2004, 2008), Element Theory (Harris 1994, Harris and Lindsey 1995, 2000; Nasukawa and Backley 2008; Backley and Nasukawa 2009; Backley 2011, 2012; Nasukawa 2014) and Particle Phonology (Schane 1984, 1995, 2005). The notion of empty syllable structure was first introduced by Clements and Keyser (1983: 107-113) in order to account for the effects of *h*-aspire in French. After that, the application of positional emptiness was extended to nuclei in order to analyse vowel-zero alternations observed in various languages such as Moroccan Arabic (Kaye 1990b), French (Charette 1991), Polish (Gussmann and Kaye 1993), English (Harris 1994) and Japanese (Nasukawa 1998, 2005a).

1.2. The role of empty nuclei

Empty nuclei play a particularly important role in Government Phonology (Kaye, Lowenstamm and Vergnaud 1985, 1990; Kaye 1990ab, 1995; Charette 1991). In this framework, vowel-zero alternations observed in various languages are assumed to be attributed to the existence of an empty nucleus in the relevant context. In Moroccan Arabic, for example, verb forms such as *ktb* show vowel-zero alternations, e.g., *tan ktib* ‘I

write', *tan kitbu* 'we write' (Ewen and van der Hulst 2001: 189; cf. Kaye, Lowenstamm and Vergnaud 1990; Kaye 1995). As these examples show, when *i* appears between *t* and *b*, no vowel appears in the neighbouring position between *k* and *t*. And conversely, when *i* appears between *k* and *t*, the consonant sequence *tb* does not have any intervening vowel. To account for this pattern, the theory assumes that empty nuclei intervene between 'adjacent' consonants such as *k-t* and *t-b*, with the lexical morpheme itself consisting only of the consonants *ktb*. The vowel *i*, the only central vowel in the Moroccan Arabic vowel system, is realised between consonants, and is assumed to be the phonetic manifestation of an empty nucleus. This analysis avoids the need to call upon rules such as vowel insertion, which are theoretically arbitrary in the sense that any vowel could be a candidate for epenthesis.

As a result of observing phonological patterns across different languages, Government Phonology also claims that all words in all languages end in a nucleus. And if a word-final nucleus is empty, it is a matter for language-specific parameter settings to determine whether this empty structure must be pronounced or not: languages in which words may end phonetically in a consonant (e.g., English and French) allow final empty nuclei to be silent, whereas languages in which words must end phonetically in a vowel (e.g., Zulu and Japanese) require final empty nuclei to be audible. The use of word-final empty nuclei makes it possible to analyse vowel epenthesis of the kind which is observed in morphologically-driven word-formation (Harris 1994: 179-181).

1.3. Problems of empty nuclei

Empty nuclei provide a useful structural tool for analysing phonological phenomena involving vowel-zero alternations. Furthermore, the notion of emptiness in nuclei has its

own merits, making phonological descriptions more restrictive and explanations more consistent. In addition, the existence of empty nuclei highlights the importance of structural representations, which ultimately serve as an essential component in all types of phonological theory, whether representation-based or computation-based.

In the interests of representational reductionism, however, the status of nuclei must also be called into question since the properties inherent in a nucleus are reducible to other phonological units: (i) *vocalicness* can be represented by vocalic features (e.g., [vocalic], [sonorant]) and (ii) *precedence* can be expressed by timing units such as skeletal positions and Root nodes.

1.4. The representation of English schwa

In addition, limiting the present argument to the vowels of English, we must address at least two questions with regard to the representation of schwa. First, the correlation between schwa and non-high vowels in vowel reduction cannot be straightforwardly accounted for if we claim that schwa is the phonetic manifestation of an empty nucleus.

- (1) *'kɒntent* 'content' NOUN - *kən'tent* 'content' ADJ
 'ɒbdʒekt 'object' NOUN - *əb'dʒekt* 'object' VERB
 'sɜːveri 'survey' NOUN - *sə'veri* 'survey' VERB

In terms of features, both non-high vowels (e.g., *ɒ* [-high, +low, +back, +round], *æ* [-high, +low, -back, -round]) and schwa ([-high, -low, +back, -round]) contain [-high], and the specification of [-high] somehow changes the values of the other features to [-low, +back, -round] in order to get in unstressed nuclear positions. These changes

appear to be unconnected because they employ different features. This misses the point that vowel reduction is actually a single process leading to a loss of lexical contrasts (Backley 2011: 53). Here we cannot find any strong correlation between the feature values for a full vowel and the feature values for the reduced vowel ə. This clearly differs from the correlation between the long high vowels *i:* and *u:* and their reduced reflexes *ɪ* and *ʊ*, respectively.

- (2) 'ri: gres 'regress' NOUN - rɪ'gres 'regress' VERB
 ri'pju:t 'repute' - ,repjʊ'teɪfən 'reputation'

The unreduced vowel *i:* and its reduced reflex *ɪ* are both marked for [+front] or [palatality]; similarly, the unreduced vowel *u:* and its reduced reflex *ʊ* both contain [+back] or [labiality]. In the same manner, the correlation between non-high vowels and schwa should be captured by a phonological property.

Second, the phonetic realisation of word-final empty nuclei is not systematically explained in the theory. For example, the word *dain* 'dine', which ends phonetically in a consonant, is considered to have a word-final empty nucleus which is phonetically unpronounceable. By contrast, the word *dainə* 'Dinah' ends in ə, which is considered to be the phonetic manifestation of a lexically-present word-final empty nucleus. If we posit that ə is the phonetic manifestation of an empty nucleus, we have to explain why the same structure has two different phonetic realisations.

1.5. English schwa is not the phonetic manifestation of an empty nucleus

In order to answer the question I raised above regarding the correlation between non-high vowels and schwa in phonological phenomena, I assume that there must be a property which is common to both.

The units of segmental representation that I adopt in the present study are those developed in Government Phonology (Kaye, Lowenstamm and Vergnaud 1985, 1990; Kaye 1990ab, 1995; Charette 1991) and Element Theory (Harris 1994, 2005; Harris and Lindsey 1995, 2000; Nasukawa and Backley 2008; Backley 2011). The (minimal contrastive) units in question are called *elements* and are taken to be components of UG; they are single-valued (monovalent) and can be phonetically interpreted in isolation. Therefore, elements are in principle free to combine with one another. The elements which are directly relevant to the present discussion are given below, each described in terms of its principal acoustic exponence (Nasukawa 2015b: 3, cf. Harris 2005, Harris and Lindsey 2000, Nasukawa and Backley 2008, Backley and Nasukawa 2009, Backley 2011).

(3)

	<i>label</i>	<i>spectral shapes</i>	<i>manifestation as a vowel</i>
A	‘mass’	mass of energy located in the center of the vowel spectrum, with troughs at top and bottom	non-high vowels
I	‘dip’	energy distributed to the top and bottom of the vowel spectrum, with a trough in between	front vowels
U	‘rump’	marked skewing of energy to the lower half of the vowel spectrum	rounded vowels

From this set of elements for describing the internal structure of (vowel) segments, the only element which is shared by unreduced *i:* and reduced *ɪ* is the |I| element. And in the equivalent back vowels, the only element common to unreduced *u:* and reduced *ʊ* is the |U| element. In the case of high vowels, then, the element which is present in the structure of an unreduced vowel remains intact when that vowel is interpreted in an unstressed position (and phonetically realised as its reduced equivalent). If |I| (or |U|), which is the only element present in *i:* (or *u:*), were to be deleted in an unstressed position, it would leave an empty nucleus. But this is not the case: the same element survives even in an unstressed nucleus.

Applying a parallel analysis to the correlation between non-high vowels and ə, following Backley (2011), I claim that the structure consisting of a sole |A| element, rather than an empty nucleus, must be the representation of ə since the only element which is shared by all non-high vowels is |A|. In vowel reduction, it appears that all elements except |A| in non-high vowels are deleted in unstressed nuclear positions, then the resulting structure containing only |A| is realised as ə.

1.6. Replacing empty nuclei by minimal contrastive units

What emerges from the preceding discussion is that, not only the status of nuclei, but also a property that is inherent in nuclei must be called into question. In the interests of representational minimalism, some recent models of phonological representation choose to dispense with one of the two established relational properties — precedence and dependency — and analyse phonological phenomena by referring only to the other property. For example, Nasukawa (2014, 2015ab) takes the view that precedence relations are not specified in representations, with the linear ordering of segments in a string being the product of dependency relations encoded in phonological structure. His approach is supported by the premise that dependency relations between units are indispensable in phonological structure, and moreover, are utilised in other modules of the grammar too. On this basis, Nasukawa (2011) argues that information pertaining to precedence relations between units is representationally redundant; instead, the dependency relations holding between representational units are sufficient to analyse phonological phenomena. According to this view, precedence is no longer to be viewed as a formal linguistic property. Rather, it is merely a by-product of phonetic interpretation executed by the Articulatory-Perceptual systems.

In the precedence-free approach to phonological representation just described, all structural units relating to precedence (e.g. timing units, CV units, skeletal positions, onsets and nuclei) are eliminated from representations. The only units which remain – and the only units which can be referred to by the grammar – are the phonological primitives (minimal contrastive units) known as *elements*. These elements – rather than syllabic constituents such as onset, nucleus and rhyme – are regarded as the basic building blocks of phonological structure. In addition, Nasukawa replaces the nucleus (which, in mainstream theories of phonological representation, is thought to play a central role in building structure) with one of the three resonance elements |A|, |I| or |U|, the choice being determined on a language-specific basis. The chosen element determines the quality of the baseline resonance in the language in question, and as such, serves as the ultimate head of a segmental structure. And when a vowel structure contains no other elements (i.e. when it is lexically empty), this baseline element is exposed and determines the phonetic quality of the default or epenthetic vowel in the language: |A| is phonetically interpreted as ə in English, |I| as i in Fijian, and |U| as u in Japanese. From cross-linguistic observations these vowels are seen to function as epenthetic vowels in the nativisation of loanwords.

1.7. Representing the vowels of English

From the set of vowel elements |A I U|, English selects |A| as its baseline resonance. A structure which contains only the baseline element |A| is phonetically realised as a central vowel – usually schwa ə, though in some dialects i is also possible.

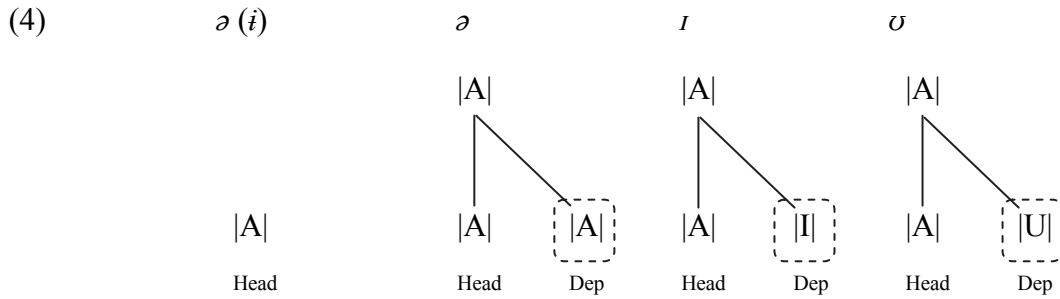

Most vowel structures also contain lexical information, however, in which case elements are added to this baseline resonance (i.e. head |A|) and form head-dependent relations within the vowel's structure. For example, when the head |A| takes |A|, |I| or |U| as its dependent, the acoustic signature of the baseline is masked by the acoustic patterns of those additional elements and the overall structure is phonetically interpreted as ə, i or u respectively.

Elements not only serve as the baseline of a given phonological structure but can also combine freely in the formation of vocalic expressions. To illustrate this, consider the mid front vowels e and æ. These are, respectively, the phonetic realisation of the |A|-headed set of |A I| and the |I|-headed set of |A I|.

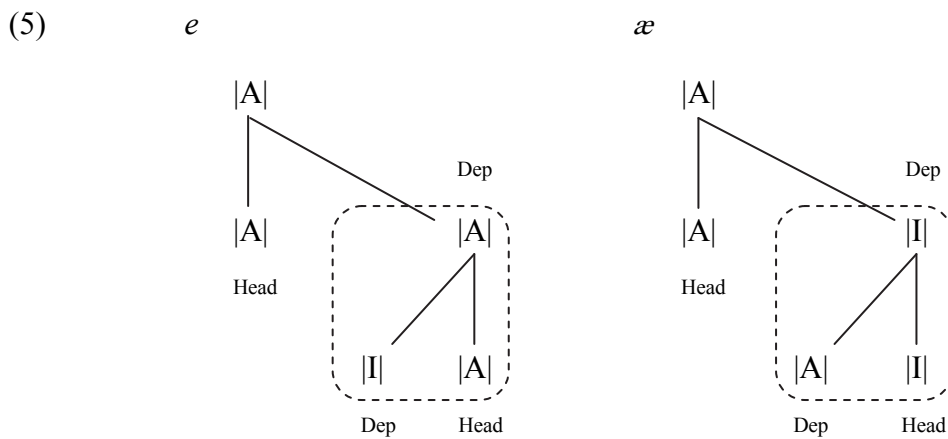

The same asymmetric relations between constituent elements are found in the structure of the mid back vowels *o* and *ɔ*. As for the other vowels, these sets can be dominated by another set: for example, the |A|-headed set of |I| and |A| ([|A|[[I|A|]]) which is dominated by the set consisting of only |I| ([|I|]) is interpreted as the closing diphthong *er*. This kind of recursive structure is also employed for representing other vowels in English. For a detailed discussion, the reader is referred to section 4.4 in chapter 4.

1.8. Vowel aperture

In this precedence-free approach, as discussed in section 1.5, English schwa must be the phonetic realisation of a sole |A| rather than an empty nucleus. Given that |A| is the baseline of vowel expressions in English, it can be represented as illustrated in (6a).

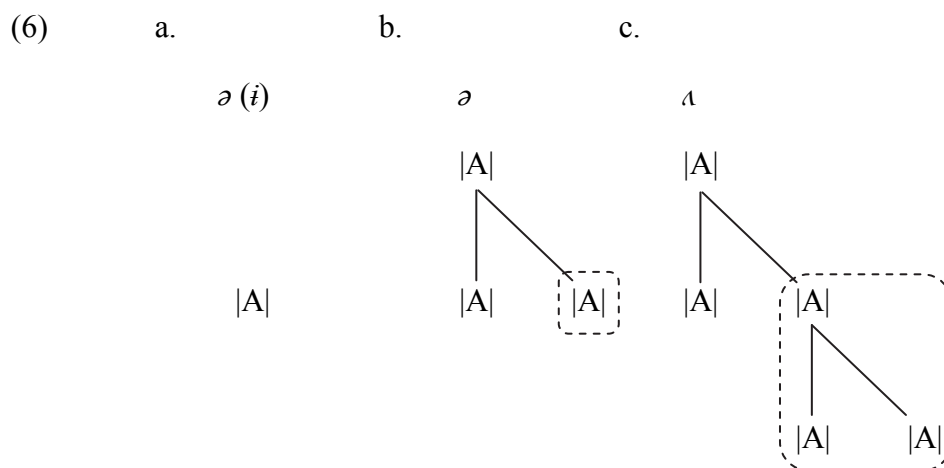

It is the structure which is involved in vowel-zero alternations, e.g., *fæməli-fæmli* ‘family’, *rʌʃ* ‘rush’ + *-z* PL → *rʌʃəz* (or in some dialects, *rʌʃiz*).¹ On the other hand, the

¹ In similar examples to this, schwa (ə) and barred-*i* (*ī*) are in fact lexically distinctive. For example, *ræʃəz* ‘rashers’ versus *ræʃiz* ‘rashes’. This suggests that they should have different

lexically-given ə which shows no vowel-zero alternation (e.g., ə of *danə* ‘Dinah’) is assumed to have the structure in (6b): the baseline |A| takes another |A| as its dependent. This must be the structure for the reduced reflex (ə) of non-high vowels in contexts where vowel reduction takes place.

In fact, vowel sonority is associated with the number of tokens of |A|: the greater the number of |A|s, the more sonorous the vowel is (i.e. the greater its degree of sonority in relative terms). The |A|-headed set of two |A|s in the middle is phonetically realised as ə while the |A|-headed set of three |A|s in the representation (6c) manifests itself as ʌ, which has a higher degree of sonority than ə.

In order to validate the proposed element structure for the vowels of English, then, in the following chapters phonological phenomena observed in English will be analysed in a way which avoids referring to precedence relations.

1.9. The organisation of this study

The structure of the present study is as follows. Chapter 2 reviews how empty nuclei have been incorporated in phonological studies, and discusses some contentious issues surrounding the phonological status and the phonetic interpretation of nuclei in the interests of structural minimalism. Then, restricting the argument to English vowels, chapter 3 reveals that the correlation between schwa (ə) and non-high vowels in vowel reduction cannot be straightforwardly accounted for if we posit that the reduced vowel ə is the phonetic manifestation of an empty nucleus. Then, following Backley (2011), I claim that ə is the phonetic manifestation of the sole element |A|, rather than an empty nucleus. Chapter 4 will be devoted to representing English vowels, including schwa, in

structures.

the context of a precedence-free approach to phonological representation, and also to analysing how the proposed structures for English vowels can accommodate observed phonological phenomena. Finally Chapter 5 brings together the results of the present study and explores some further consequences of the proposed model.

2 *Empty categories in phonology*

2.1. Introduction

In generative grammar, the notion of empty categories plays an important role not only in syntax but also in phonology. Phonological empty categories were first introduced in CV phonology (Clements and Keyser 1983), where empty onsets were proposed to analyse the phenomenon of *h*-aspire in French. The notion of empty categories was thereafter extended to nuclear positions, as applied to the analysis of vowel-zero alternations in various languages such as Moroccan Arabic (Kaye 1990a), French (Charette 1991), Polish (Gussmann and Kaye 1993), English (Harris 1994) and Japanese (Nasukawa 2005a). Analyses employing empty nuclei are typically found in frameworks such as Licensing/Government-based Phonology (Kaye, Lowenstamm and Vergnaud 1985, 1990; Kaye 1995), Element Theory (Harris 1994, 1997, 2005; Harris and Lindsey 2000) and Strict CV Phonology (Lowenstamm 1996; Scheer 1998, 2004).

Among the frameworks mentioned above, there is a noteworthy difference between empty onsets and empty nuclei in terms of the phonetic interpretability of featureless positions. It is generally assumed that the former type of empty category is able to participate in phonological processes but does not manifest itself phonetically; positions in the latter type (featureless nuclei) may be phonetically realised as a vowel. An empty nucleus is deemed to be realised as the most unmarked central vowel in the vowel space: for example, *ə* in English (Kaye 1990b, Charette 1991, Harris 2005), *i* in

Cilungu (Bickmore 2007) and *u* in Japanese (Nasukawa 2005a).¹ These vowels typically function as epenthetic vowels in morphological processes such as regular plural suffixation (the suffix *-z* ‘-(e)s’ is added to a noun: e.g., *rʌʃ* ‘rush’ + *-z* → *rʌʃz*) and regular past tense suffixation in English (the suffix *-d* ‘-(e)d’ is added to a verb: e.g., *wed* ‘wed’ + *-d* → *wedəd*). Languages also use default epenthetic vowels as a means of avoiding impossible consonant sequences in, for example, the nativisation of loanwords; these epenthetic vowels may be regarded as the phonetic realisation of empty nuclei (e.g., *mbeki* → *əmbeki* in English, *disk* ‘disk’ in English → *disuku* in Japanese, *displei* ‘display’ in English → *disipilei* in Fijian).

On the other hand, in some theoretical approaches an empty nucleus may be permitted to be phonetically silent. In order to suppress empty nuclei phonetically, Licensing/Government-based Phonology (Kaye, Lowenstamm and Vergnaud 1985, 1990; Kaye 1995) and Element Theory (Harris 1994, 1997, 2005; Harris and Lindsey 2000) employ a principle called Proper Government, which controls the phonetic interpretation of empty nuclei: an empty nucleus may be phonetically silent if it is properly governed by its following melodically-filled nucleus (Kaye 1990ab, Harris 1994). Few papers discuss the difference between empty onsets and empty nuclei in terms of phonetic interpretability (cf. Nasukawa 2010ab).

This chapter argues how the notion of empty categories in general, and empty nuclei in particular, are employed in phonology and how they are involved in phonological processes. In addition, it discusses the phonetic realisation of empty nuclei – which have no segmental structure in their representation – by referring to a range of phonological phenomena.

¹ Rather than utilizing the symbols // and [] for referring to speech sounds, this work employs italicized letters in order to avoid implying the notions of phoneme and allophone.

This chapter is organized as follows. Section 2.2 describes how empty categories are employed in syntax. Then, after briefly overviewing how the notion of empty categories was introduced in phonology, section 2.3 shows how empty nuclei are phonetically realised in relation to the Domain-final-empty-nucleus Parameter and Proper Government. Section 2.4 discusses the way in which empty nuclei are realised differently from one language to another, but also shows how they regularly correspond to the most central area of the vowel space. In section 2.5 I examine the widely held assumption that an empty nucleus is phonetically realised as \emptyset in English, and explore some representational problems regarding word-final empty nuclei in English. Finally section 2.6 provides a summary of the chapter.

2.2. Phonetically-unrealised categories in syntax

Hartmann, Hegedus and van Riemsdijk (2008: 4-8, cf. Chomsky 1981) argue for the existence of three major groups of phonetically-unrealised categories in syntax:

- (1) a. categories that are specified for silence in the lexicon (silent functional and lexical categories, e.g., *PRO*, *pro*, *wh*-operators)
- b. categories that can remain unpronounced or can be deleted under specific circumstances (e.g., some types of ellipsis), and
- c. categories derived from displacement processes (traces, copies).

Well-known examples in group (1a) are *PRO* (big pro) and *pro* (little pro), the former appearing in control structures (caseless positions) in embedded non-finite clauses (e.g.,

John wanted PRO to go home.) and the latter being a silent pronominal which is assumed to occur in the subject position of a finite clause and has case in languages such as Italian (e.g., *pro parla* ‘s/he speaks.’). Another example is the *wh*-operator (e.g., *What* in the interrogative sentence *What did Bill say he wants to buy ___?*) which binds a phonetically empty (unpronounceable) variable (shown above as “___”); it can also participate in, for example, parasitic gap and relative clause constructions.

VP ellipsis is a typical example of (1b). Take *John bought a book and Mary did, too* as an example. The second conjunct is interpreted as *Mary did buy a book, too*, the VP part of which is then assumed to delete (i.e., *Mary did ~~buy a book~~, too*).

An example of (1c) is an NP trace, which appears when a DP moves out of its underlying position (e.g., *Mary_{DP} seems [t_{DP}] to like John* ← [] *seems Mary to like John*).

All of these unpronounceable categories in syntax have no phonological content, and for this reason are known as phonologically “empty categories”. Empty categories are employed cross-linguistically, although different languages allow for different categories to be phonologically empty.

2.3. Empty categories in phonology

2.3.1. Empty onsets

Phonological empty categories were originally introduced by Clements and Keyser (1983: 107-113) in order to account for French words exhibiting *h*-aspiré. Such words begin phonetically with a vowel but behave phonologically as if they begin with a consonant.

The following data illustrates the phenomenon (Clements and Keyser 1983: 107-113).

(2) *Consonant truncation* in French before words beginning with *h*-aspiré

- a. petit héros [ɛʁo] → peti[ʔ][ɛʁo] ‘little hero’
- b. bon héros [ɛʁo] → bo[ʔ][ɛʁo] ‘good hero’
- c. six héros [ɛʁo] → si[ʔ][ɛʁo] ‘six heroes’

Before the word *héros*, which is pronounced on its own as [ɛʁo] (beginning phonetically with a vowel), the final consonant of the word to its left in (2a-c) is truncated. The same effect is observed in front of a word beginning with a consonant, as illustrated below.

(3) *Consonant truncation* before words beginning with a consonant

- a. petit livre [livʁ] → peti[ʔ][livʁ] ‘little book’
- b. bon livre [livʁ] → bo[ʔ][livʁ] ‘good book’
- c. six livres [livʁ] → si[ʔ][livʁ] ‘six books’

On the other hand, before words such as *ami* [ami] (also beginning phonetically with a vowel) the final consonant of the word to the left in (3a-c) is pronounced rather than truncated.

(4) *Liason* before words beginning with a vowel

- a. petit ami → peti[t]ami ‘little friend’
- b. bon ami → bo[n]ami ‘good friend’
- c. six amis → si[z]amis ‘six friends’

In the literature (Tranel 1981) before Clements and Keyser (1983), *h*-aspiré words are assumed to be lexically vowel-initial, and their phonological behavior is analysed by exploiting some arbitrary rules and ad hoc features such as [-context Consonant Insertion] and [-context Consonant Elision].

In order to distinguish the two types of vowel-initial words (*héros* exhibiting *consonant truncation* and *ami* exhibiting *liaison*), however, Clements and Keyser (1983: 108) propose that *h*-aspiré is represented as a C-unit in the syllable structure which dominates no consonant (i.e., has no melodic content), as depicted in (5a).

(5) a. *héros* [ɛʁo]

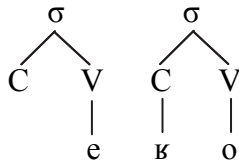

b. *ami* [ami]

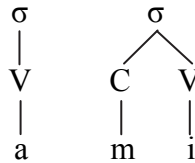

The initial C in (5a) is phonetically not realised (silent), yet the word itself behaves phonologically as if it begins with a consonant. The following rule for consonant truncation, therefore, applies not only before C-initial words but also before a word like *héros* [ɛʁo].

(6) Consonant truncation rule

$$C \rightarrow \emptyset / \text{ ____ } (\#) \{ \#, C \}$$

By contrast, vowel-initial words like *ami* do not trigger the rule in (6), the consonant before *ami* being phonetically pronounced. As a result, liaison is observed. In French, then, empty onsets are able to participate in phonological processes without being phonetically

realised.

In the model of phonological representation called Government Phonology (Kaye, Lowenstamm and Vergnaud 1985, 1990; Kaye 1995), which offers a particularly restrictive approach to the representation of prosodic structure, any phonologically legitimate (licensed) position *must* receive phonetic interpretation even if there is no melodic material in its internal structure. This means that the melodically-empty onset in (5a) must be phonetically interpreted. According to Charette (1991: 95), however, an empty onset never phonetically manifests itself since it is always followed by a nucleus in accordance with Onset Licensing.

(7) Onset Licensing (Harris 1994: 160)

An onset head position must be licensed by a nuclear position.

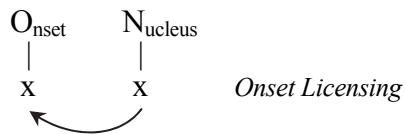

The licenser, which sanctions the preceding onset position, can at the same time be a proper governor of its licensee if its licensee is melodically empty. A properly-governed position is then phonetically not realised.

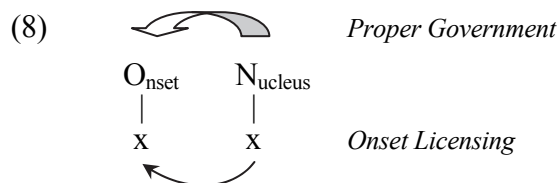

Proper Government is a type of dependency relation between prosodic units which has the effect of suppressing the phonetic manifestation of an empty position. It will be discussed in more detail in the context of empty nuclear positions in the following section.

2.3.2. Empty nuclei

The notion of an empty position, as discussed in the previous section, originally referred to onsets and was introduced to analyse the phenomenon of *h*-aspire in French. Then, the application of ‘segmental emptiness’ was extended to nuclear positions, as found in the analysis of vowel-zero alternations in various languages such as Moroccan Arabic (Kaye 1990a), French (Charette 1991), Polish (Gussmann and Kaye 1993), English (Harris 1994) and Japanese (Nasukawa 1998, 2005a).

Empty nuclei play a particularly important role in the framework of Government Phonology (Kaye, Lowenstamm and Vergnaud 1985, 1990; Kaye 1995). In this framework, as mentioned in the previous section, any phonologically legitimate (licensed) position *must* receive phonetic interpretation even if there is no melodic material in its internal structure. So a melodically empty nucleus is not an exception.

In order for a given melodically empty nucleus to remain silent, Government Phonology requires it to be p[rosodically/properly]-licensed.

- (9) The Phonological Empty Category Principle (ECP) (Kaye 1990b: 313, 1995: 295; Harris 1994: 193):

A p-licensed (empty) category receives no phonetic interpretation.

P-licensing is considered to be established in the following contexts:

- (10) P-licensing contexts (Kaye 1992: 306, cf. Kaye 1990b: 313):
- a. Domain-final (parameterised) (Harris and Gussmann 1998, 2002)
 - b. Proper Government
 - c. Magic Licensing (parameterised)

There are some other p-licensing contexts, but they are not considered to have been established cross-theoretically (cf. Charette 1998: 170). The only commonly agreed contexts are those in (10).

The first context is domain-final. A domain-final empty nucleus is p-licensed if the setting of the Domain-final-empty-nucleus Parameter in (11a) is ON. Examples are found in languages such as English, Icelandic and Polish. The illustration given in (11b) is the structure of the English word *feɪk* ‘fake’ where the p-licensed domain-final nucleus is phonetically silent.

- (11) a. Domain-final-empty-nucleus Parameter (DFENP)

Final empty nucleus p-licensed? [OFF/ON]

- b. [ON] *feik* ‘fake’ in English c. [OFF] *feikuu* ‘fake’ in Japanese

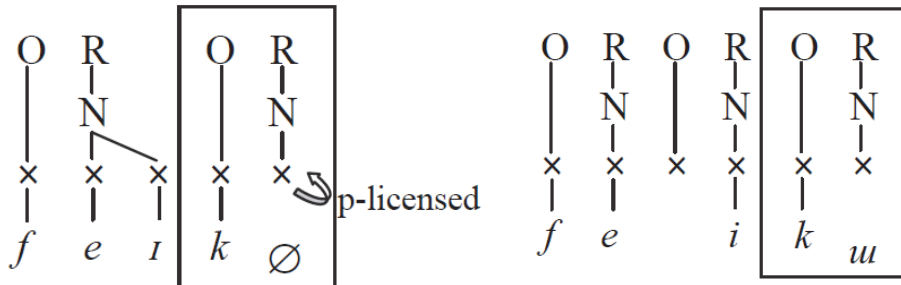

O = onset, R = rhyme, N = nucleus, x = skeletal position, timing slot

- d. Typology of p-licensing of final empty nucleus

[OFF] e.g. Zulu, Telugu, Japanese, Cilungu

ON e.g. English, Icelandic, Polish, Luo

The existence of p-licensed empty nuclei is supported by ample empirical evidence (Harris and Gussmann 1998, 2002) which will be discussed in section 2.3.3.

On the other hand, if the setting of the parameter is OFF, a final empty nucleus is not p-licensed; as a result, the position must receive phonetic interpretation. Examples come from languages such as Zulu, Telugu and Japanese, in which the neutral vowel of the language in question usually manifests itself as a realisation of the unlicensed final empty nucleus. In the case of Japanese, as illustrated in (11c), this is the high back unrounded vowel *u*.

The second type of p-licensing is established by Proper Government. As given in (12a), Proper Government is established if the structure in question matches one of the conditions in (12a).

(12) a. Proper Government (Kaye 1990b: 314, Harris 1994: 191):

A nucleus α properly governs an empty nucleus β iff:

- i. α and β are adjacent on the nuclear projection.
- ii. α is not itself p-licensed.
- iii. α is not a government-licensor (for its onset).

b. *fæmæli* ‘family’

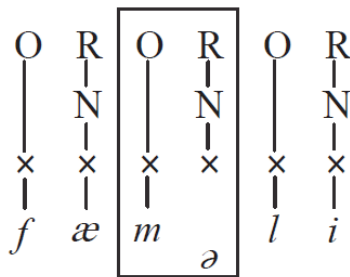

c. *fæmli* ‘family’

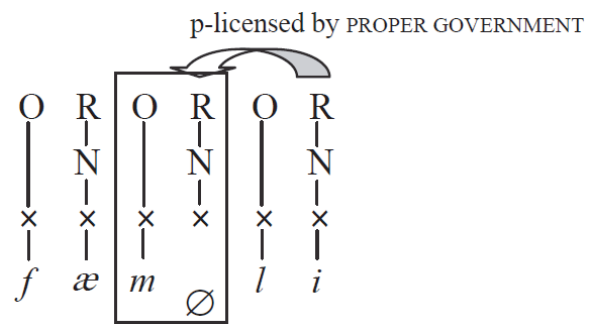

In the case of the English word ‘family’, at the level of nuclear projection the word-internal empty nucleus is immediately followed by the word-final filled nucleus, in accordance with (12ai). In this case we say that the word-internal empty nucleus is p-licensed as a result of being properly governed by the final filled nucleus. This is illustrated in (12c), where the p-licensed empty nucleus receives no phonetic interpretation. *fæmæli* is thus pronounced as *fæmli*. Otherwise, the word-internal empty nucleus must receive phonetic interpretation, which in English is usually a central vowel quality close to schwa ə . This type of vowel-zero alternation is reported in many other languages too, such as Moroccan Arabic (Kaye 1990a), French (Charette 1991) and Japanese (Nasukawa 1998, 2005a).

In Moroccan Arabic (MA), for example, consonant sequences such as *ktb* illustrate vowel-zero alternations (Ewen and van der Hulst 2001: 189; cf. Kaye, Lowenstamm and Vergnaud 1990; Kaye 1995).

- (13) a. tan ktib ‘I write’
 b. tan k̄itbu: ‘we write’

The high central vowel *i* in (13) is assumed to be the phonetic manifestation of an empty nucleus in Moroccan Arabic. The examples in (13) are given below with their prosodic structures.

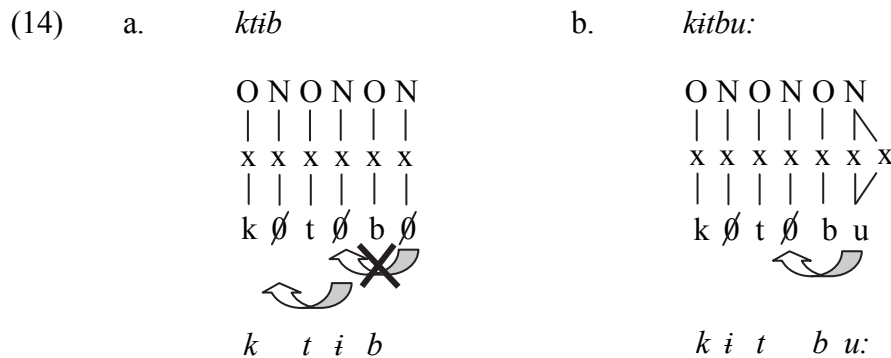

The final empty nucleus in (14a) cannot properly govern the preceding empty nucleus since the governor must be a phonetically realised nucleus. As a result, the second empty nucleus must be phonetically realised as *i*. This phonetically-interpreted nucleus of the second syllable can now be a proper governor for the preceding empty nucleus in the first syllable, which then remains silent.

On the other hand, the second nucleus in (14b) is phonetically unrealised since it is properly governed by the following filled nucleus (*u:*). Since the phonetically silent

second nucleus is now unable to function as a proper governor for the preceding (left-most) nucleus, this first nucleus must be phonetically realised as *i*.

Another example is given in Charette (1991), which also employs empty nuclei and *Proper Government* in order to analyse the distribution of schwa in French: a ban on a sequence of two empty nuclei (which are phonetically realised as two schwas) at the level of nuclear projection. Examples are given in (15).

(15) a. *dəvniʁ* ‘devenir (to become)’

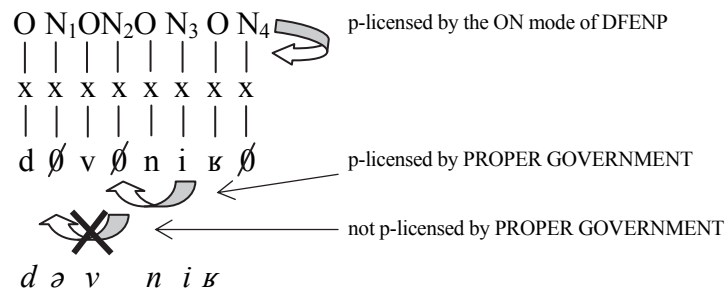

b. *əsəvliʁ* ‘ensevelir (to bury)’

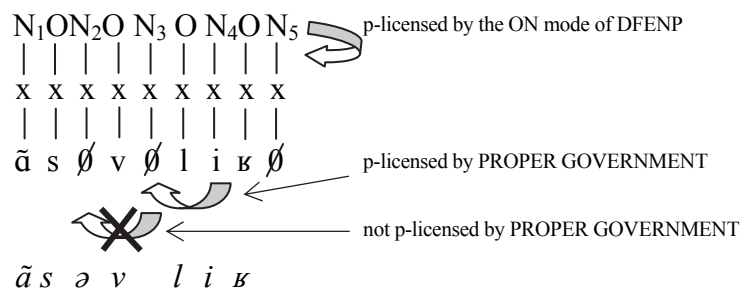

In (15a), N₂ is phonetically silent since the position meets all of the conditions in (12); N₂ (proper governee) and N₃ (proper governor) are adjacent at the level of nuclear projection; N₃ stands to the right of N₂; and N₃ is not itself p-licensed. With respect to the relation between N₁ and N₂, they are adjacent at the nuclear projection

level, but N_2 fails to p-license its preceding position N_1 since N_2 is p-licensed by being properly governed by N_3 . As a result, the vowel \emptyset is phonetically realised in the initial vocalic position N_1 . As for N_4 , it is p-licensed to be silent because of the ON setting of the final-empty-nucleus parameter in (11).

In the case of (15b), on the other hand, the ON setting of the final-empty-nucleus parameter in (11) p-licenses the final position N_5 to be phonetically silent. Since N_3 is p-licensed by N_4 , it receives no phonetic interpretation and fails to properly govern its preceding position N_2 . As a result, N_2 must be phonetically realised as \emptyset .

Japanese also exhibits the same process involving Proper Government. According to Nasukawa (2005a), in Japanese postnasal voicing assimilation takes place between two onset positions only if they are mediated by an empty nucleus which is followed by a filled nucleus at the nuclear level. This is illustrated in (16).

(16) *tombo* ‘dragonfly’

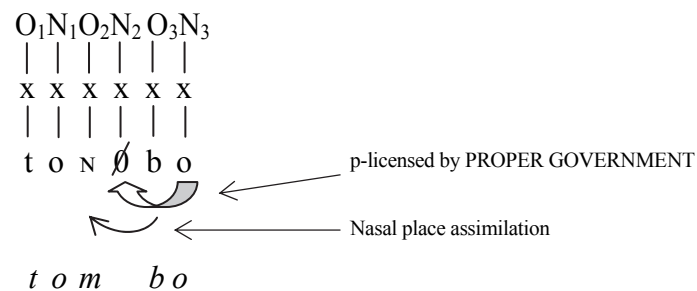

In the above representation, an empty nucleus N_2 is phonetically unrealised so that the sequence consisting of O_2 , N_2 and O_3 is phonetically manifested as a string of two consonants. In the framework of Government Phonology (Kaye 1990ab, 1995; Charette 1990, 1991, 1998; Harris 1994), an unrealised empty nucleus like this must be

also p-licensed by being properly governed. As shown in (16), Proper Government is established if an empty nucleus is followed by a filled nucleus at the nuclear level; otherwise, the empty position is phonetically interpreted.

The third context of p-licensing is found in domain-initial positions at the level of nuclear projection in words such as ‘Spain’, ‘stake’ and ‘skate’. Here, an empty nucleus followed by *s* in a rhymal complement (‘coda’) position can be parametrically p-licensed by virtue of the Magic-licensing parameter.

- (17) a. Magic-licensing parameter (Kaye 1992: 306):
 Initial empty nucleus followed by *s* in its rhymal complement
 p-licensed?

- b. [ON] *spem* ‘Spain’ in English c. [OFF] *españa* ‘España’ in Spanish

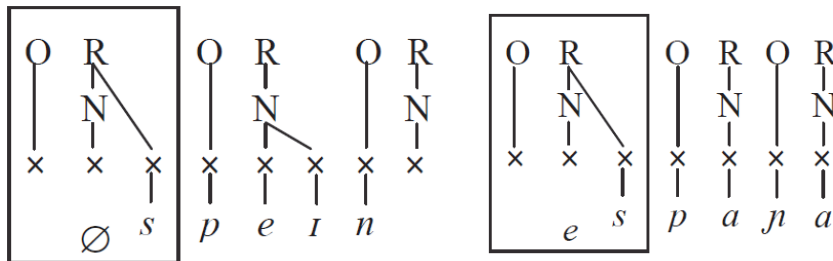

The structure in (17b) was first introduced by Kaye (1992) in order to represent the heterosyllabic status of word-initial *sC* sequences cross-linguistically. Kaye (1992) presents theoretical arguments (e.g., the binarity theorem) to claim that *sC* sequences do not form a branching onset. He also provides plenty of empirical support from a number of different languages (e.g., Italian, Ancient Greek, European Portuguese and Southern British English). Then, he argues that the *s* and *C* belong to different syllables: in all

languages *s* occupies a rhymal complement, preceded by an empty nucleus. The *C*, on the other hand, is syllabified into the onset of the following syllable. Following the phonological Empty Category Principle in (6), like other types of empty nucleus, the first empty nucleus in (17b) is p-licensed by virtue of the ON setting of the Magic-licensing parameter. Consequently, as shown in (17b), the first p-licensed empty nucleus receives no phonetic interpretation in English. On the other hand, if the setting is OFF, the empty position must be phonetically interpreted. In the case of Spanish, which allows branching rhymes as shown in (17c), the unlicensed initial empty nucleus manifests itself as *e*.

2.3.3. Word-final empty nuclei

As illustrated above, Government Phonology regards word-final consonants as being in a syllable onset followed by an empty nucleus (Kaye 1990ab, Kaye, Lowenstamm and Vergnaud 1985, 1990), rather than as occupying a syllable coda (Jensen 1993, *et passim*). There are some well-established arguments that word-final consonants in English occupy an onset followed by an empty nucleus (Kaye 1990ab; Kaye, Lowenstamm and Vergnaud 1985, 1990; Harris 1994, 1997; Harris and Gussmann 1998, 2002; Nasukawa 2004, 2005a), rather than a coda.

2.3.3.1. Arguments against the final-coda view

Harris and Gussmann (1998, 2002) present a clear, theory-neutral discussion of the facts, providing evidence (i) against the final-coda analysis for English and (ii) in support of the view that word-final consonants occupy an onset followed by an empty nucleus. In their arguments against the traditional view that word-final consonants occupying the syllable

coda, Harris and Gussmann show how the behavior of a word-final consonant differs from that of a word-internal coda, drawing evidence from three different aspects of language: *syllable typology, word stress and vowel length*.

Concerning syllable typology, there is a body of literature (Kaye, Lowenstamm and Vergnaud 1985, 1990; Harris and Gussmann 1998) which describes this in terms of two independent parameters: one controlling the presence of word-internal codas ('*internal VC•?*' in (18)) and another (dis)allowing word-final consonants ('*final VC]?*' in (18)).

(18)

Word-final C (...V <u>C</u>)	Word-internal C (...V <u>C</u> .C...)			
	Not permitted		Permitted	
Not permitted	I	...V.CV]	III	...V(C).CV]
Permitted	II	...V.CV(C)]	IV	...V(C).CV(C)

As illustrated above, the intersection of the two parameters generates four different syllable types: (I) both word-final C and word-internal C are not permitted (e.g., Zulu); (II) word-final C is permitted but word-internal C is not permitted (e.g., Luo); (III) word-final C is not permitted but word-internal C is permitted (e.g., Italian) and (IV) both word-final C and word-internal C are permitted (e.g., English). This four-way typology obviously undermines the assumption that a word-final consonant should be equated automatically with a word-internal coda.

Second, there is a mismatch between the behavior of word-internal codas and the behavior of word-final consonants from the viewpoint of word-stress assignment in English. In English, a word-internal coda contributes to the weight of the preceding

syllable, while a word-final consonant fails to contribute to syllable weight in this way; instead, it is regarded as extrametrical. Examples are shown below (Harris and Gussmann 1998: 143).

- | | | | | | | |
|------|----|---------|----|----------|----|----------|
| (19) | a. | tormént | b. | cajóle | c. | édit |
| | | lamént | | maintáin | | astónish |
| | | collápe | | caróuse | | cáncel |

In the English stress system the final syllable of a verb attracts stress when it is heavy (i.e., its rhyme has a long vowel, a diphthong, or a short vowel followed by a consonant). Otherwise, stress is assigned to the penultimate syllable. Examples in (19a) and (19b) show the final stress pattern while the penultimate pattern is found in (19c). A point to be noted here is the pattern in (19c) where the final consonant (e.g., [t] of ['edit]) does not contribute to the weight of the preceding rhyme. That is, it is treated as extrametrical since the final consonant does not make the preceding rhyme heavy. A typical example is [kæn.səl] 'cancel' of which [kæn] and [səl] are metrically unequal. If they were treated as being equal, [səl] would be stressed. A similar situation is attested in many other languages besides (Hayes 1995). The extrametricality of a word-final consonant thus provides further evidence for the view that a word-final consonant is not regarded as being in a syllable coda.

The third piece of evidence comes from the relation between the ability of a syllable nucleus to support a length distinction and the identity of a following consonant. When a super-heavy VVC · syllable appears word-internally, severe distributional restrictions control the characteristics of the final C. They are summarized by Harris and Gussmann (1998: 144), as follows.

- (20) a. C must be a fricative or a sonorant, e.g. *pastry*, *oyster*, *danger*, *council*, *boulder*, *ancient* (*[beɪptɪ], *[a:kmi]);
- b. if sonorant, C must be homorganic with the following onset, e.g. *council*, *paltry* (*[kawnbəl], *[pɔ:lbrɪ]);
- c. in the case of (b), the place of C is (almost) invariably coronal (*[kɑmpəl], *[i:mpri]).

On the other hand, word-final VVC exhibits no restrictions on the specification of C. Not only word-final VVC but also word-final VC can have any consonant (except *ŋ*). In other words, a final consonant imposes no systematic constraints on the length of the preceding vowel. This is illustrated below.

- (21) a. VVC *slide* [slɑɪd], *spoon* [spu:n], *soap* [səʊp], *rake* [reɪk],
 boot [bu:t], *feel* [fi:l], *leaf* [li:f], *reach* [ri:tʃ]
- b. VC *lid* [lɪd], *run* [rʌn], *back* [bæk], *top* [tɒp], *step* [step],
 foot [fʊt], *fill* [fɪl], *spliff* [splɪf], *rich* [rɪtʃ]

This also reinforces the point that the C of word-final VVC and VC cannot easily be identified as a coda if the word-internal cognate is a coda.

Further evidence that word-final C cannot be equated with a word-internal coda comes from some word-formation processes in English. Closed syllable shortening, for example, requires the vowel preceding a word-internal coda to be short, whereas the same condition does not cause a vowel preceding a word-final consonant to shorten.

(22) Closed-syllable shortening in English

a.	word-final		b.	word-internal	
	<i>per<u>ce</u>ive</i>	[i:]		<i>per<u>cep</u>tion</i>	[e]
	<i>des<u>cri</u>be</i>	[aɪ]		<i>des<u>crip</u>tion</i>	[ɪ]
	<i>re<u>du</u>ce</i>	[u:]		<i>re<u>du</u>ction</i>	[ʌ]
	<i>f<u>iv</u>e</i>	[aɪ]		<i>f<u>ift</u>y</i>	[ɪ]
	<i>w<u>is</u>e</i>	[aɪ]		<i>w<u>is</u>dom</i>	[ɪ]
	<i>re<u>ta</u>in</i>	[eɪ]		<i>re<u>te</u>nitive</i>	[e]

This also supports the argument that a word-final consonant cannot be identified as a coda, given that it shows different patterns from those of a word-internal coda. Similar arguments in other languages such as Icelandic and Ponapean are also cited by Harris and Gussmann.

2.3.3.2. Word-final C as an onset followed by an empty nucleus

In order to support the view that word-final consonants in English occupy an onset rather than a coda, Harris and Gussmann (1998) discuss the distributional (phonotactic) patterns of final consonants, claiming that word-final consonant clusters (CC) are similar to internal coda-onset clusters (C·C), as shown below.

(23)	CC clusters	Internal, Final	Internal, Final
	a. STOP-STOP:	<i>chapter, apt</i>	<i>vector, sect ...</i>
	b. SONORANT-STOP:	<i>pamper, damp</i>	<i>winter, flint ...</i>
	c. FRICATIVE-STOP:	<i>mister, mist</i>	<i>whisper, wisp ...</i>
	d. SONORANT-FRICATIVE:	<i>cancer, manse</i>	<i>dolphin, golf ...</i>

If we adopt the notion that word-final consonants occupy a coda, then we must treat the distributional similarity between the word-internal C·C and the word-final CC] patterns as being purely accidental. On the other hand, if we take the view that word-final consonants occupy an onset (i.e., that both C₂ of C₁·C₂ and C₂ of C₁C₂] are onsets), the distributional regularities need be specified only once. No coincidental regularities are assumed.

In addition, under the final-onset view, we can straightforwardly account for the differences between word-final (V)VC] and word-internal (V)VC· (e.g., *pastry* ['peɪstri], *shoulder* ['ʃəʊldə]) in terms of the relation between the ability of a syllable nucleus to support a length distinction and the identity of a following consonant. Under the final-onset view, the restrictions imposed on word-internal VVC· in (20) do not apply to word-final VVC] since the final C of VV·C] is in fact not a coda consonant. Phenomena such as closed-syllable shortening and closed rhyme shortness are also analysed in the same way (Harris 1994; Harris and Gussmann 1998, 2002).

So, on the assumption that word-final consonants are onsets rather than codas, these consonants must be followed by a nucleus since a nucleus is obligatory in a syllable. This has been formalized in various ways in the literature (Clements and Keyser 1983, Prince and Smolensky 1993), most commonly by appeal to the Onset Licensing Principle (Harris 1994: 160), which has been discussed in section 2.3.1 and is repeated below for convenience.

(24) Onset Licensing Principle

An onset head position must be licensed by a nuclear position.

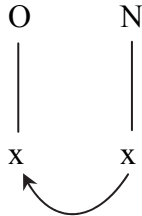

In order for a theory of phonological representation to maintain a level of restrictiveness, the syllable where a final onset appears must also conform to the principle. Given this, a final onset must be followed by a nucleus. In the case that a given word ends with a consonant that occupies an onset position, the following nucleus must be phonetically silent – that is, melodically empty or featureless. As discussed in section 2.3.2, a word-final empty nucleus is not phonetically realised if it is p-licensed by virtue of the ON setting of the Domain-final-empty-nucleus Parameter in (11a).

2.4. The phonetic interpretation of empty nuclei

2.4.1. Vowel-zero alternations

In Government Phonology and Element Theory, as briefly discussed in section 2.3.2, if an empty nucleus is not p-licensed (as a result of the ECP (9)) it must be phonetically realised. In general, it is realised as a vowel quality corresponding to the central area of

the vowel space: for example, *ə* in English (Kaye 1990b, Charette 1991, Harris 2005), *i* in Cilungu (Nasukawa 2010b) and *u* in Japanese (Nasukawa 2005a).

In English, for example, the classic environment for an empty nucleus is word/domain-final position, as shown below.

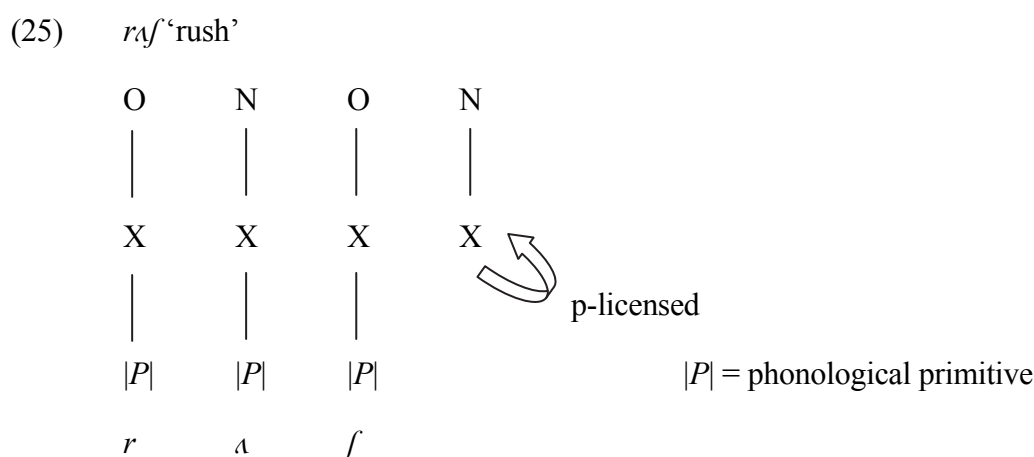

The final empty nucleus in (12) remains silent because in English the setting of the Domain-final-empty-nucleus Parameter in (11a) is ON. However, when the plural suffix *-z* '-(e)s' is added to the end of this word in the formation of regular plural nouns,² the

² Regular plural formation, which adds <-(e)s> to nouns, shows three alternants: *əz* (*iz*), *s* and *z*, as given below (Oishi and Nasukawa 2011: 61).

- (i) *əz* kisses, places, bridges, catches, cabbages, bushes, garages
- (ii) *s* lips, lists, marks, graphs, hundredths
- (iii) *z* hugs, clubs, sides, dreams, fans, apples, ears, ties, parties, issues, cellos,
operas

In the framework of generative phonology, *z* (as opposed to *s* or *əz*) is considered to be the lexical form of <-(e)s> since its generative cost is viewed as the lowest in derivational terms. On this basis, English regular plural formation is expressed by the following rewrite rules.

final empty nucleus of *rʌʃ* ‘rush’ is phonetically realised in order to avoid having an impossible sequence of sibilants /z/. It is widely acknowledged that the OCP (Obligatory Contour Principle: Leben 1973) requires the epenthetic vowel ə (or in some dialects, ɪ) to break up the two successive sibilants. As illustrated in (19), this epenthetic vowel is regarded as the phonetic manifestation of an empty nucleus which is sandwiched by two sibilants.³

(26) *rʌʃ* ‘rush’

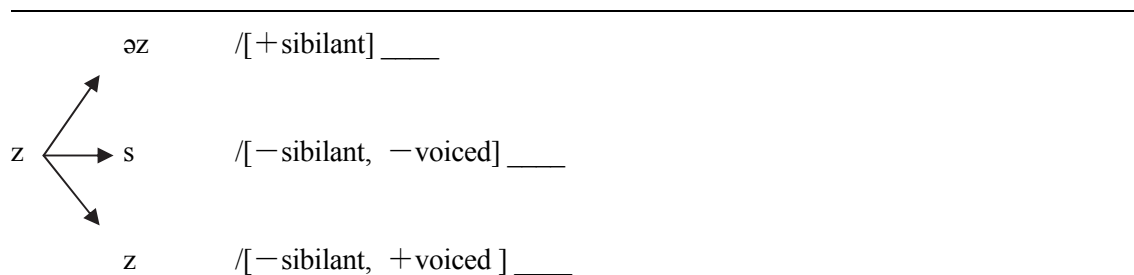
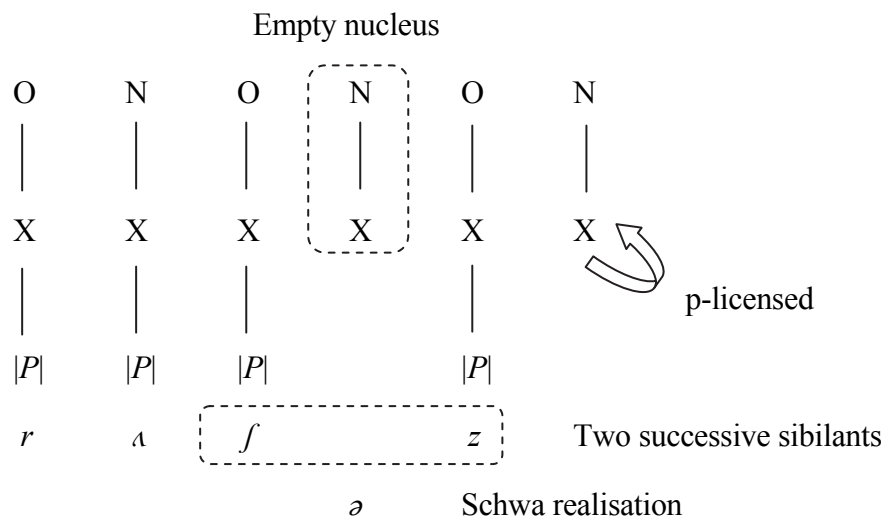

³ When ə appears as a result of this type of OCP, its context is always conditioned: it occurs in suffixed forms such as (26) but never between free morphemes, e.g., *rʌʃzəʊn* ‘rush zone’.

The same process applies in English past tense suffixation, which relies on vowel epenthesis to break up the impossible sequences of coronal stops *tt*, *dd*, and *td*. Take the English word *wed* ‘wed’ as an example.

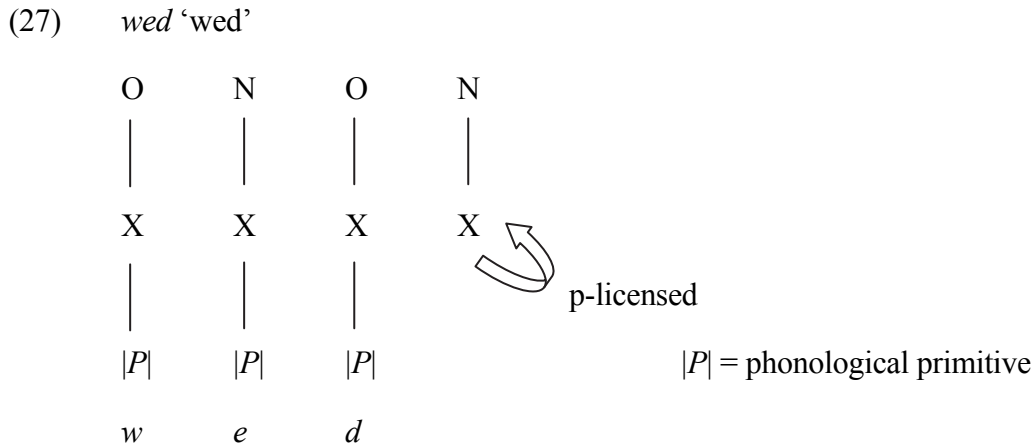

This consonant-final word is also assumed to have a final-empty nucleus. When the verb undergoes regular past tense suffixation, the suffix *-d* ‘-(e)d’ is added to the word. As shown in (28), the epenthetic vowel is also typically *ə*, which is considered to be the phonetic realisation of an empty nucleus flanked by two coronal stops.

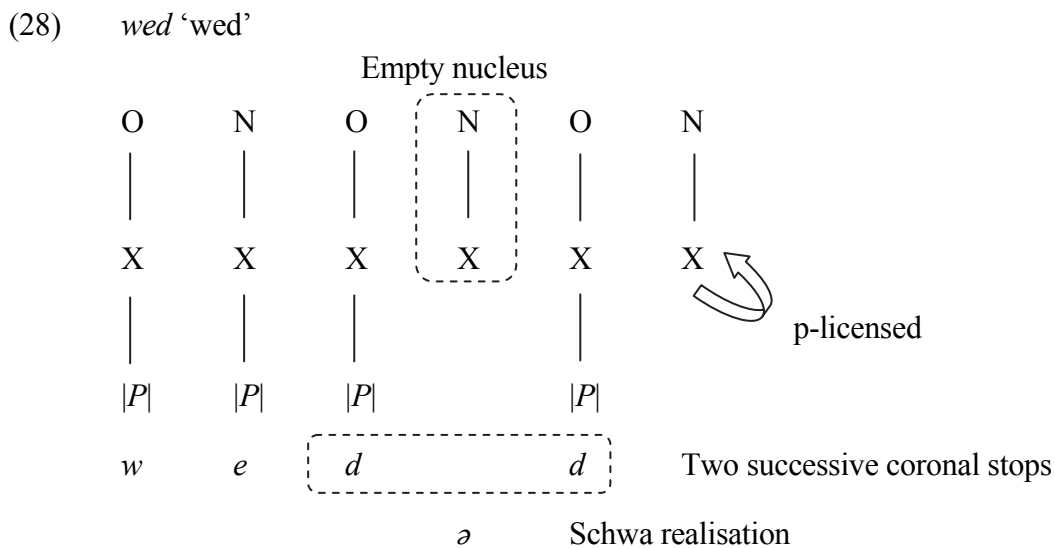

Unlike English, the empty nucleus in Cilungu (spoken in parts of Zambia and Tanzania: Bickmore 2007) is realised as *i* (Nasukawa 2010b: 201-203). Examples are found in phenomena involving the 1st singular subject marker, which manifests itself as syllabic nasal /ń/ when it is followed by a vowel.

- (29) a. *n-áá-fúl-il-á* ‘I have just washed for’ < /ń-a-fúl-il-á/
 b. *n-éél-è* ‘that I fish’ < /ń-él-é/

However, the syllabic nasal /ń/ is reinterpreted as *i* when it stands before a nasal-initial object marker or root (i.e., macrostem), as given below (Bickmore 2007: 113, Nasukawa 2010b: 202).

- (30) a. *i-mí'l-é* ‘that I swallow’ < /ń-mil-é/
 b. *i-ńé'p-é* ‘that I tie a knot’ < /ń-ńép-é/
 c. *i-mú-zìik-il-é* ‘that I bury for him/her’ < /ń-mu-ziik-il-e +H/
 d. *i-mí'z-il-é* ‘I have swallowed’ < /ń-mil-il-e +H/
 e. *i-mìl-á* ‘and then I swallowed’ < /ń-mil-a +H/
 f. *ì-mw-á* ‘and then I drank’ < /ń-mo-a +H/

In Nasukawa (2010b), the 1st singular subject marker /ń/ is considered to have the following structure (tonal properties are omitted, as they are irrelevant to the present discussion).

(31) The 1st singular subject marker /ń/

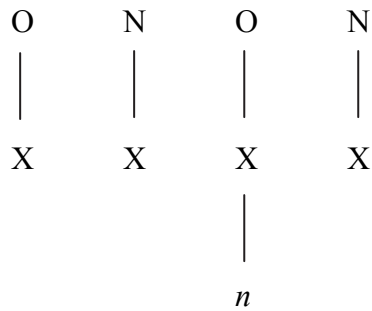

The structure in (31) consists of a melodically empty onset-nucleus sequence before a nasal in the onset followed by another empty nucleus (for a detailed discussion of the validity of this structure, refer to Nasukawa 2010b). Given this structure, a form constructed by adding the 1st singular subject marker is represented as in (32).

(32) *i-mí-l-é* ‘that I swallow’ < /ń-mil-é/

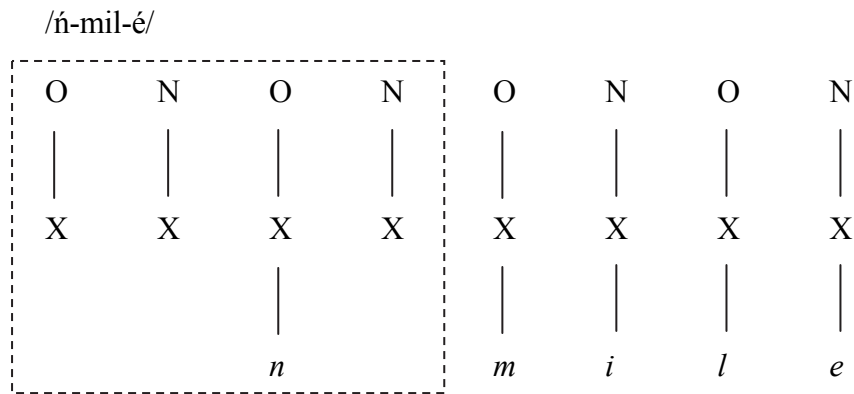

In this configuration, the second empty nucleus from the left is silent since it is p-licensed as a result of being properly governed by the following melodically-filled nucleus. This is illustrated below.

(33) *i-mi'l-é*

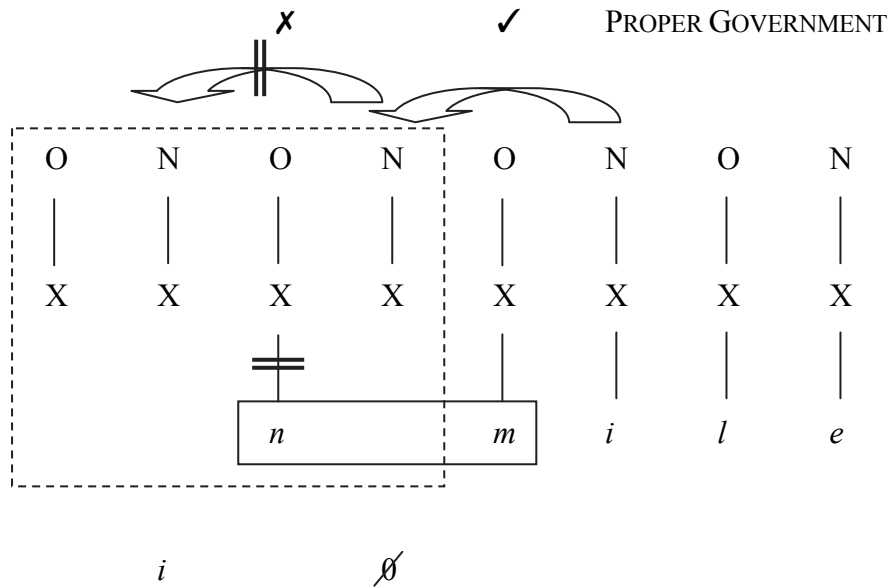

By contrast, the first empty nucleus in (33) cannot be p-licensed via Proper Government since its potential governor (the following nucleus) is already p-licensed by virtue of being properly governed and thus cannot be a governor itself. In this context, the unlicensed initial empty nucleus must be phonetically realised. In the case of Cilungu the unlicensed empty nucleus phonetically manifests itself as *i*. At the same time, the nasal in the 1st singular subject marker in (33) is suppressed since two successive nasals are banned by the OCP in Cilungu.

Vowel-zero alternations of this kind are found in many other languages, thereby supporting the existence of an empty nucleus and its (language-specific) phonetic quality.

2.4.2. Epenthetic vowels in the nativisation of loanwords

Nasukawa (2014: 9-12) notes that epenthetic vowels are sometimes used to break up impossible consonant sequences in the nativisation of loanwords, and that this may also

tell us something about the phonetic realisation of empty nuclei. Among the various forms of vowel epenthesis, one common strategy is default vowel insertion. A typical example is found in Japanese, which employs *u* as a default epenthetic vowel. (Note that *o* is inserted only when the preceding consonant is either *t* or *d* as in *torikku* ‘trick’ and *doriimu* ‘dream’. An explanation of *o*-epenthesis is beyond the scope of the present discussion.) Some examples are given below.

(34) Default vowel epenthesis in Japanese (Uffmann 2006: 4)

- a. *φesutibaru* ‘festival’
- b. *ɕiguzagu* ‘zigzag’
- c. *disuku* ‘disc’
- d. *furuutaimu* ‘full-time’
- e. *ɕippu koodo* ‘zip code’
- f. *aruubaito* ‘part-time job’ < German ‘Arbeit’

In Government Phonology, the structure of the word *disk* ‘disk’ is as follows.

(35) *disk* 'disk' in English

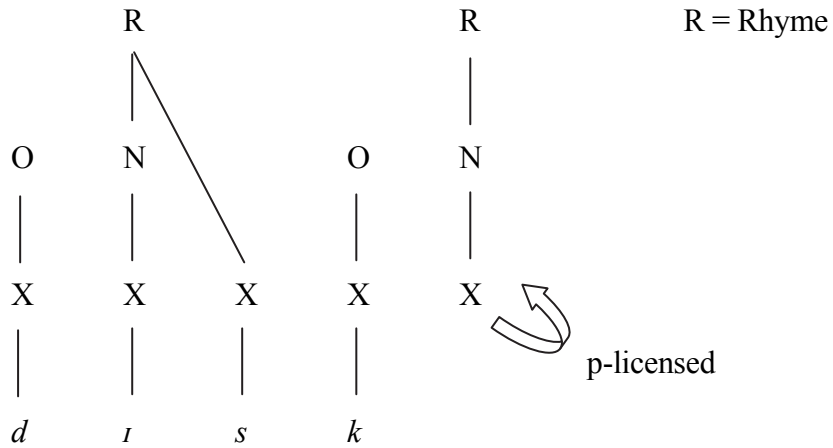

According to Nasukawa (2011, 2015b), on the other hand, the syllable structure of Japanese does not permit branching structures such as the branching rhyme in (35). Since it employs strict CVCV (ONON) structure, segmental sequences are mapped onto a CVCV sequence as shown below.

(36) *disukuu* 'disk' in Japanese

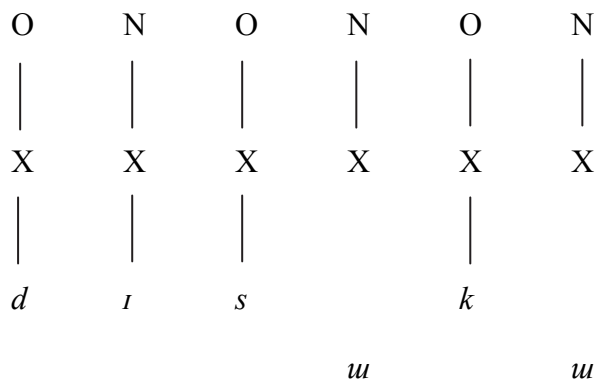

As (36) shows, the word-medial and word-final nuclei are melodically empty. However, neither nucleus can remain silent because neither is p-licensed: (i) Proper Government is not established between the medial and final nuclei, and (ii) the setting of the Domain-final-empty-nucleus Parameter is OFF in Japanese. As a result, they are phonetically realised as *u*, which is the most central vowel in this language.

In contrast to Japanese, Fijian employs *i* as its default epenthetic vowel (Schütz 1978, 1985; Kenstowicz 2007; Kumagai 2014). To confirm this, Nasukawa, Onuma and Koizumi (2014) investigates what kind of vowel epenthesis is observed when Fijian creates a novel loanword by borrowing from English (rather than established loanwords that are listed in dictionaries, as it is not clear from the data based on established loanwords whether a word has been nativised in Fijian – and if so, when – or whether a word has been borrowed directly from English or indirectly via another language such as French.). The patterns examined are all based on data that was collected by Nasukawa, Onuma and Koizumi from four native Fijian informants in Fiji during August 2014. The four informants were given approximately 400 English words and asked to respond by reproducing these words in a nativised form. A partial data set of loanwords in Fijian is given below.

(37) Epenthetic vowels in Fijian (Nasukawa, Onuma and Koizumi 2014)

a. /i/

disgrace /dɪs'greɪs/	→	ⁿ disi ^ŋ gereisi
display /dɪs'pleɪ/	→	disipi ⁱ lei
scripts /skripts/	→	siki ⁱ ripiti ⁱ

b.	/e/, /i/	apt /æpt/	→	ap <u>e</u> t <u>i</u> s <u>i</u>
c.	/e/	extra /'ekstrə/	→	ek <u>e</u> s <u>e</u> t <u>e</u> r <u>a</u>
d.	/a/	butler /'bʌtlə/	→	bat <u>a</u> l <u>a</u>
		after /'ɑ:ftə/	→	af <u>a</u> t <u>a</u>
		tufts /tʌfts/	→	taf <u>a</u> t <u>a</u> s <u>a</u>
e.	/a/, /e/	upwind /,ʌp'wɪnd/	→	ap <u>a</u> w <u>i</u> ⁿ <u>d</u> e
f.	/o/	already /ɔ:l'redi/	→	ol <u>o</u> r <u>e</u> ⁿ di
g.	/o/, /i/	crosswise /'krɒswaɪz/	→	ko <u>r</u> o <u>s</u> i <u>w</u> a <u>s</u> i
		topmost /'tɒpməʊst/	→	top <u>o</u> mo <u>s</u> i <u>t</u> i
h.	/o/, /e/	Congress /'kɒŋɡres/	→	ko <u>o</u> g <u>e</u> r <u>e</u> s <u>e</u>
		software /'sɒftweə/	→	sof <u>o</u> t <u>e</u> w <u>e</u> a
i.	/u/	approve /ə'pru:v/	→	ap <u>u</u> ruu <u>β</u> e
j.	/æ/ → /e/	mansion /'mænʃən /	→	me <u>n</u> isoni
		value /'vælju:/	→	β <u>e</u> lu(e)

Focusing in particular on epenthetic vowels between consonants and after word-final consonants, the results obtained from the four informants are shown below. (Note that the data does not include any vowels which were copied from source words in the donor language, English.)

(38) Epenthetic Vs

a.	Informant A	b.	Informant B
	i 49.7%		i 57.2%
	e 35.4%		e 28.4%
	a 8.0%		a 2.4%
	o 2.2%		o 4.6%
	u 4.5%		u 7.1%
c.	Informant C	d.	Informant D
	i 70.1%		i 69.4%
	e 14.6%		e 22.5%
	a 9.4%		a 5.0%
	o 1.4%		o 0.5%
	u 4.2%		u 2.5%

According to our investigation, among the five vowels in the system, the vowels *a*, *o*, *u* are the ones that appear to have been influenced by the quality of adjacent consonants. For example, in the word ‘approve’ the informants gave the nativised pronunciation *apuru:βe*, where we assume the first *u* comes as a result of being influenced by the place feature of the preceding consonant *p*. However, limiting the present discussion to

epenthetic vowels that are more or less context-free, the data shows a strong preference for the front vowels *i* and *e* as epenthetic vowels in Fijian. Between these vowels, *i* is maximally unmarked, underspecified, and is phonetically the shortest and the least peripheral in the vowel space (Kenstowicz 2003, Uffmann 2006).

The representation of *dis'plei* 'display' in English is given in (39) using three branching constituents: a branching rhyme, a branching onset and a branching nucleus.

(39) *dis'plei* 'display' in English

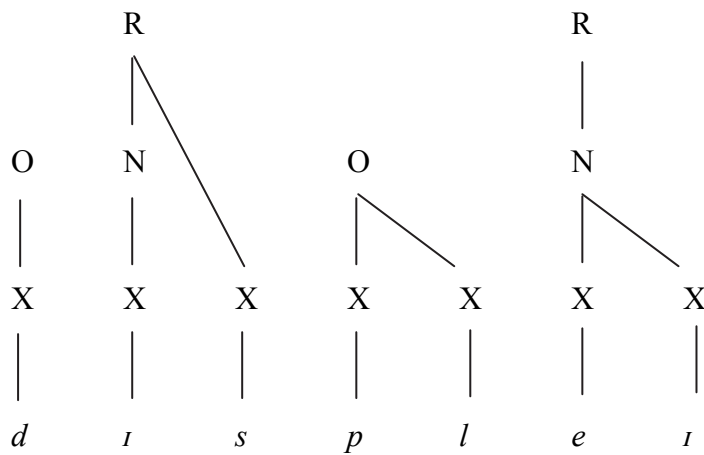

When this word is nativised in Fijian, which has the same CVCV syllable structure found in Japanese, the segmental sequence in (39) is mapped onto the CVCV (ONON) template as follows.

(40) *disipilei* ‘display’ in Fijian

O	N	O	N	O	N	O	N	N
X	X	X	X	X	X	X	X	X
<i>d</i>	<i>i</i>	<i>s</i>		<i>p</i>		<i>l</i>	<i>e</i>	<i>i</i>
			<i>i</i>		<i>i</i>			

As (40) shows, the second and third nuclei from the left are melodically empty. Like Japanese, these nuclei cannot remain silent since neither is p-licensed via Proper Government. As a result, they phonetically manifest themselves as the default vowel *i*. The vowel *i* is also the epenthetic vowel in many other languages such as Yoruba (Pulleyblank 1988, 1998), Haya (Byarushengo 1976) and Cilungu (Bickmore 2007, Nasukawa 2010b).

English is one of the languages which uses ə as its default epenthetic vowel. As discussed in Nasukawa (2014), English differs from the languages discussed so far in that the epenthetic vowel is inserted before word-initial NC sequences (which are impossible in English) when they appear word-initially in the source language.

(41) English (Nasukawa 2014)

Mpumalanga	<i>əm.pu:mə'�æŋgə</i>
mbeki	<i>əm'beki</i>
Ndola	<i>ən'dəvlə</i>
nguni	<i>əŋ'gu:ni</i>

Following Nasukawa (2014), the structure of word-initial NC sequences is represented in (42), where an empty nucleus with the rhyml complement (informally ‘coda’) stands word-initially. As stated in (17), the magic-licensing parameter (Kaye 1992: 306) allows this structure only if the rhyml complement is occupied by *s* in English. In the case of (42), the structure does not allow magic licensing to take effect because the rhyml complement is occupied by the nasal *m*. Accordingly, the initial empty nucleus must be phonetically interpreted.

(42) *əm* 'beki' 'mbeki' in English

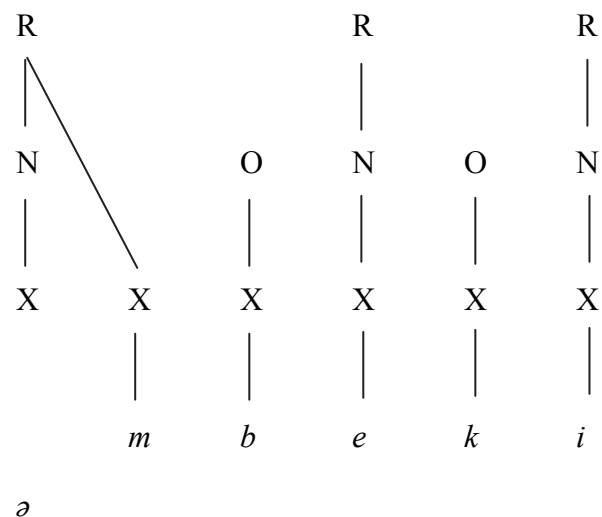

In the case of English, as briefly discussed earlier, an empty nucleus is phonetically realised as *ə*, so the word ‘mbeki’ is realised as *əm* 'beki.

Schwa is the default epenthetic vowel in many other languages too, such as French (Noske 1982, Charette 1991), Dutch (Ewen and van der Hulst 2001) and German (Brockhaus 1995, Wiese 1996).

Thus far the vowels *u*, *i*, *ə* have been referred to as default epenthetic vowels. There are further claims that not only these vowels but also *e* and *a* behave like default epenthetic vowels: *e* in Gengbe (Abaglo and Archangeli 1989) and *a* in Tswana (Batibo 1995). If confirmed, these cases are rather unusual, however: although the quality of the epenthetic vowel differs from one language to another (Uffmann 2006), the vowels *i*, *u*, *ə* are regularly observed cross-linguistically.

(43) Epenthetic vowels in loanwords (Uffmann 2006: 1080)

Yoruba	kíláàsi	‘class’	(Akinlabi 1993)
Kikuyu	ngirathi	‘glass’	(Mwihaki 2001)
Japanese	suutoraiku	‘strike’	(Park 1987)
Samoaan	sikauti	‘scout’	(Cain 1986)
Fijian	sipiinidzi	‘spinach’	(Kenstowicz 2003)

2.5. Schwa as the phonetic interpretation of empty nuclei in English?

In the Government Phonology literature (Harris 1994, *et passim*), as already discussed earlier in this chapter, and in Element Theory, English schwa is defined as the phonetic manifestation of an empty nucleus. This allows us to explain not only the vowel-zero alternations discussed in section 2.4.1 but also the pattern of unstressed vowel reduction in English. A typical example is stress shift in sets of English words that are etymologically related (Backley 2011, Nasukawa 2014).

(44) Unstressed vowel reduction in English (Hawkins 1984: 177, cf. Oishi and Nasukawa 2011: 121)

a.	photograph	—	photography
	<i>'fəʊtəgrɑ:f</i>		<i>fə'tɒgrəfi</i>
b.	diplomat	—	diplomacy
	<i>'dɪpləmæt</i>		<i>dɪ'pləʊməsi</i>
c.	phonology	—	phonological
	<i>fəʊ'nɒlədʒi</i>		<i>fəʊnə'lɒdʒɪkəl</i>
d.	Canada	—	Canadian
	<i>'kænədə</i>		<i>kə'neɪdiən</i>

The examples in (44) show that full vowels appear when they are stressed, while schwa (ə) appears when they are unstressed (cf., contextually *i* sometimes appears) (Bacley 2011: 50-53). Harris (1994, 2005) claims that the appearance of ə is attributed to the complete suppression of lexically-given phonological primitives in unstressed weak positions. Take *'kænədə* 'Canada' as an example. Its lexical representation contains full vowels in all positions, as given in (45a) (where [F] denotes a phonological primitive).

(45) a. The lexical representation of 'Canada'

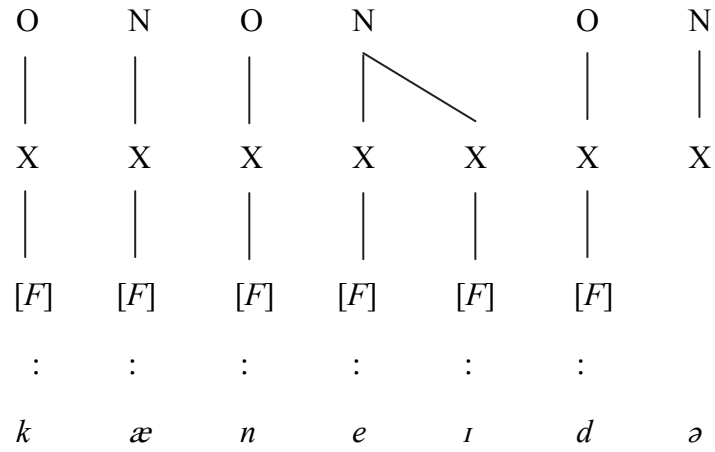

b. 'kænədə 'Canada'

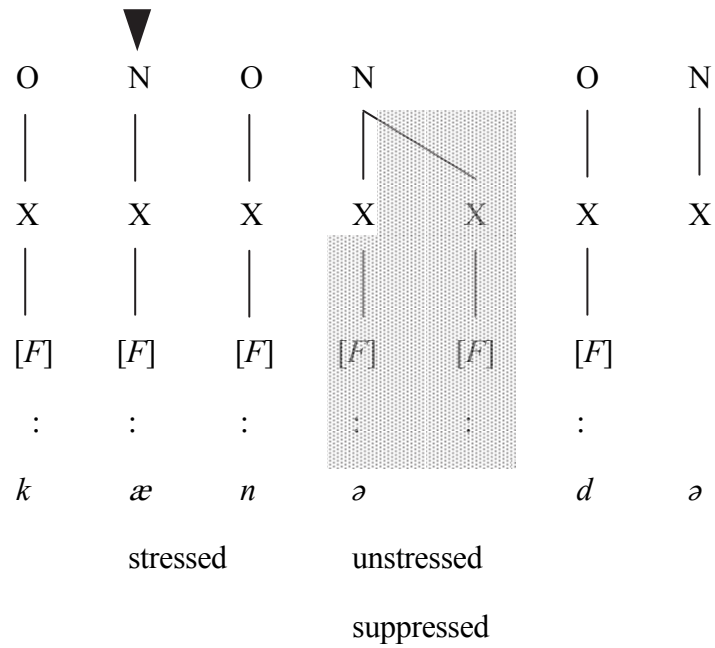

c. 'kæneɪdiən' 'Canadian'

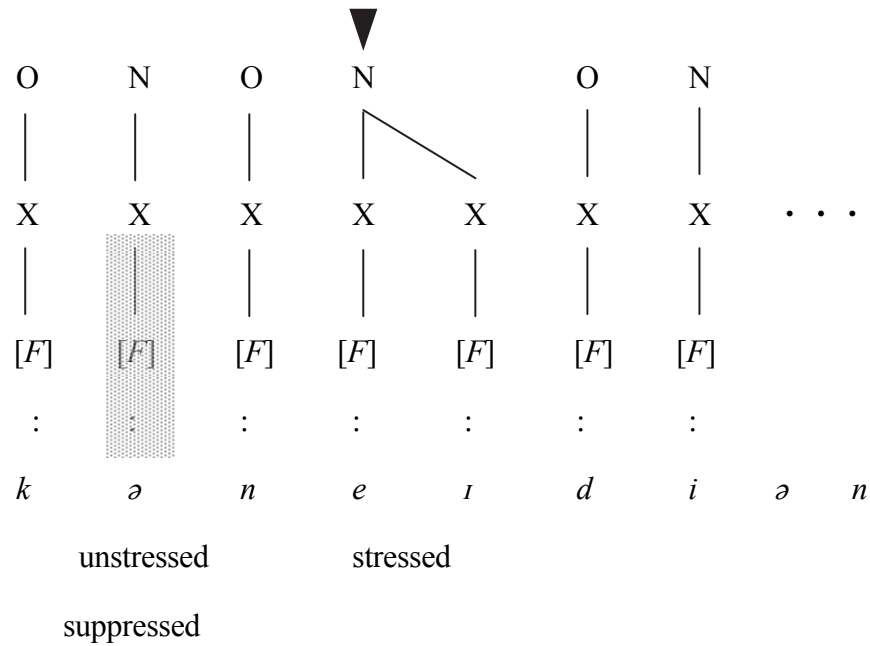

When the leftmost vowel is stressed, the lexically-specified primitives must be phonetically realised (as *æ*), while all primitives in the following unstressed vowel are suppressed (and the second position of the branching nucleus also fails to be licensed), as shown in (45b). As a result, the empty nucleus (the second vowel from the left) is pronounced as *ə*. By contrast, (45c) shows that the lexically-specified primitives in the second vowel from the left must be phonetically interpreted and realised as *eɪ*, while those in the initial unstressed vowel are suppressed and the position is realised as *ə*.

In derivational terms, then, we must recognise two different types of empty category: (i) an empty category which has no lexically specified primitives (e.g., the final schwa of 'kænədə' 'Canada'), and (ii) an empty category in which all lexically-specified primitives are suppressed under certain prosodic conditions (e.g., the penultimate schwa of 'kænədə' 'Canada' < 'kæneɪdə'). The first (word-final) type of empty category raises the question of what kind of mechanism prevents the word-final empty nucleus from

being silent. The word-final empty nucleus, which is phonetically realised as ə, should be in principle silent (i.e. 'kænədə should be *'kænəd, as in (46)) in accordance with the Domain-final-empty-nucleus Parameter in (11a), since the setting of the parameter is ON in English.

(46) *'kænəd 'Canada'

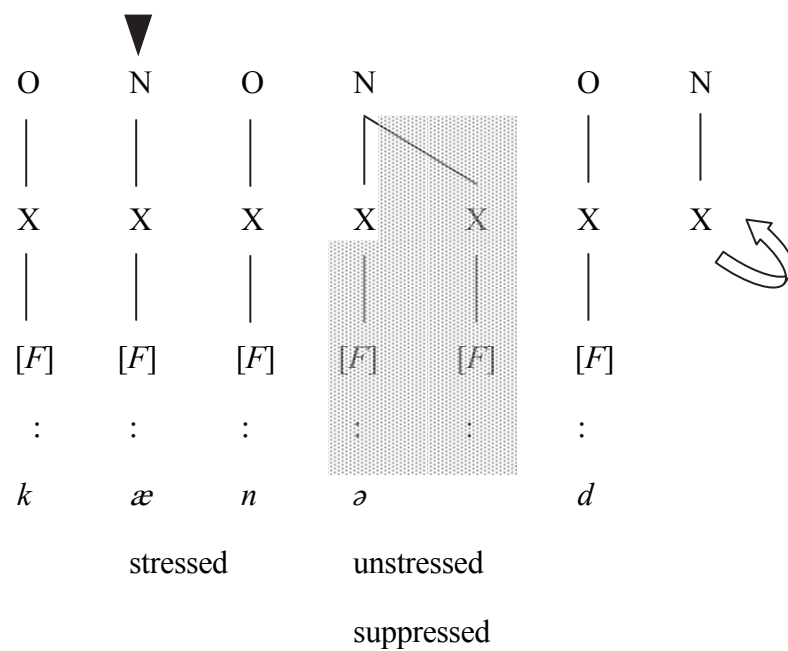

As Harris (1994: 181-182) discusses, a related question also arises: we must explain how the representations of, for example, *dain* 'dine' and *dainə* 'Dinah' are distinct.

(47) *dʌm* ‘dine’ in English

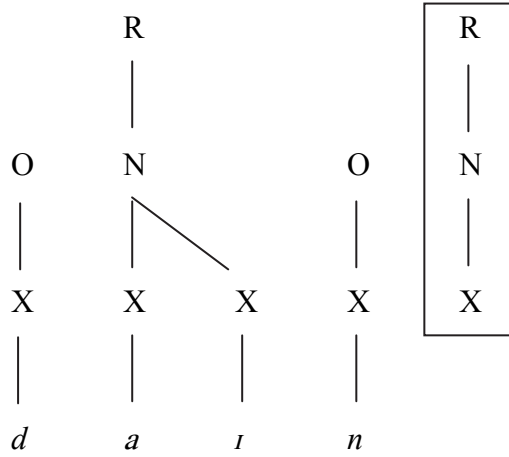

In both cases, as illustrated in (47) and (48), the relevant domain ends in an empty nucleus. However, the same structures are phonetically interpreted in different ways: the word-final empty nucleus in (47) is phonetically silent while the word-final empty nucleus in (48) phonetically manifests itself as \emptyset .⁴

⁴ The same problem is found in Particle Phonology (Schane 1984, 2005) where an empty V is phonetically interpreted as \emptyset .

(48) *dʌmə* ‘Dinah’ in English

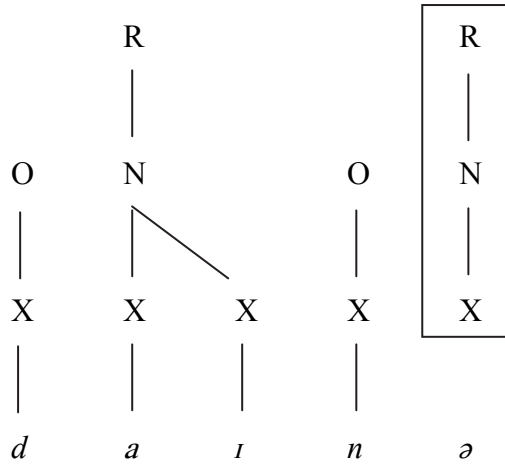

To answer to this question, Harris (1994: 182) proposes the following two structures.

(49) a. Empty nucleus

b. Schwa *ə*



In (49), '@' represents emptiness and is sometimes referred to as an identity element; it is intended to refer to a state in which no primitives are specified. Here the emptiness (@) is treated as a phonological entity like other phonological primitives (e.g., features, elements, components, particles, gestures). In (49b), on the other hand, the association line between the skeletal position X and @ denotes autosegmental licensing, the

establishment of which is essential for @ to be phonetically interpreted. According to Harris (1994), as depicted in (49b), the nucleus that autosegmentally licenses @ is phonetically realised as ə. On the other hand, since this licensing relation is not established in (49a), the unlicensed structure phonetically is silent. According to Harris, only the structure in (49a) can be considered as a genuine empty nucleus.

Without employing an additional representational object such as @, it seems difficult to explain how apparently identical domain-final empty nuclei such as those in *dam* ‘dine’ and *damə* ‘Dinah’ can be phonetically interpreted in different ways. However, without introducing any additional categories like @, the following chapter will investigate the distributional patterns of schwa in English and propose an appropriate structure for the segment in question.

2.6. Summary

Empty nuclei play a particularly important role in Government Phonology (Kaye, Lowenstamm and Vergnaud 1985, 1990; Kaye 1990ab, 1995; Charette 1991). In this framework, vowel-zero alternations observed in various languages are assumed to be attributed to the existence of an empty nucleus in the relevant context. In Moroccan Arabic, for example, verb forms such as *ktb* show vowel-zero alternations, e.g., *tan ktib* ‘I write’, *tan kitbu* ‘we write’ (Ewen and van der Hulst 2001: 189; cf. Kaye, Lowenstamm and Vergnaud 1990; Kaye 1995). As these examples show, when *i* appears between *t* and *b*, no vowel appears in the neighbouring position between *k* and *t*. And conversely, when *i* appears between *k* and *t*, the consonant sequence *tb* does not have any intervening vowel. To account for this pattern, the theory assumes that empty nuclei

intervene between ‘adjacent’ consonants such as *k-t* and *t-b*, with the lexical morpheme itself consisting only of the consonants *ktb*. The vowel *i*, the only central vowel in the Moroccan Arabic vowel system, is realised between consonants, and is assumed to be the phonetic manifestation of an empty nucleus. This analysis avoids the need to call upon rules such as vowel insertion, which are theoretically arbitrary in the sense that any vowel could be a candidate for epenthesis.

As a result of observing phonological patterns across different languages, Government Phonology also claims that all words in all languages end in a nucleus. And if a word-final nucleus is empty, it is a matter for language-specific parameter settings to determine whether this empty structure must be pronounced or not: languages in which words may end phonetically in a consonant (e.g., English and French) allow final empty nuclei to be silent, whereas languages in which words must end phonetically in a vowel (e.g., Zulu and Japanese) require final empty nuclei to be audible. The use of word-final empty nuclei makes it possible to analyse vowel epenthesis of the kind which is observed in morphologically-driven word-formation (Harris 1994: 179-181).

Empty nuclei provide a useful structural tool for analysing phonological phenomena involving vowel-zero alternations. Furthermore, the notion of emptiness in nuclei has its own merits, making phonological descriptions more restrictive and explanations more consistent. In addition, the existence of empty nuclei highlights the importance of structural representations, which ultimately serve as an essential component in all types of phonological theory, whether representation-based or computation-based.

In the interests of representational reductionism, however, the status of nuclei must also be called into question since the properties inherent in a nucleus are reducible to other phonological units: (i) *vocalicness* can be represented by vocalic features (e.g.,

[vocalic], [sonorant]) and (ii) *precedence* can be expressed by timing units such as skeletal positions and Root nodes.

3 *The representation of English schwa*

3.1. Introduction

This chapter discusses the representation of English schwa (ə), whose segmental structure has been represented by an ‘empty’ expression in theories such as Element Theory, Dependency Phonology, Government Phonology and Particle Phonology.

Because of its distribution and a high frequency of occurrence, schwa is considered to be the most common vowel in English. This is because many of the full vowels alternate with schwa in unstressed syllables (e.g., əd'maɪə 'admire' → ædmə'reɪʃən 'admiration'). Thus, it is sometimes referred to as a ‘weak’ vowel because it never appears in a ‘strong’ (i.e., stressed) position. It is also treated as an epenthetic vowel inter-consonantly in some inflected forms such as –təd 'lifted' and –səz 'passes'. Another characteristic of schwa is that it is often the target of elimination (e.g., pə'tetəʊ 'potato' → ptetəʊ, 'lɪtəl 'little' → lɪt).

The issue of how to characterise vocalic segments has been one of the most widely debated areas of inquiry in the phonological literature. And to date, phonological theories have come up with several different systems for representing vocalic representations. For example, Distinctive Feature Theory (Chomsky and Halle 1968) represents English schwa by employing two-valued features such as [±high] and [±low]. However, theories employing distinctive features have so far been unable to express either the inherent weakness of schwa or to account for its high frequency without referring to external devices such as Markedness Theory. In alternatives to feature theory, such as in Element Theory, schwa is considered to be the ‘exceptional’ vowel even

though it frequently manifests itself in various contexts. The special status of ə is often explained by claiming that it is structurally an ‘empty’ vowel, meaning that it is not specified for any phonologically significant properties in its lexical structure. In these approaches (Schane 1984, 2005; Anderson and Ewen 1987; Harris 1994; Harris and Lindsey 1995; Kaye, Lowenstamm and Vergnaud 1985, 1990; van der Hulst 1988; van Oostendorp 2003; Browman and Goldstein 1992), schwa is variously referred to as the ‘cold’ vowel, the ‘particleless’ vowel, or as the realisation of the ‘centrality component’ or the ‘neutral element’.

Following these approaches, this chapter maintains that the identity of schwa should be represented phonologically without reference to any external devices such as Markedness Theory: it should be captured by referring only to melodic structure. To achieve this, I shall assume a vocabulary of phonological features defined by the three vowel primitives [A I U]. In accordance with recent trends – and in contrast to distinctive feature theories – this approach does not incorporate any external devices such as Markedness Theory (Anderson and Ewen 1987; Harris 1994; Harris and Lindsey 1995, 2000; Kaye, Lowenstamm and Vergnaud 1985; Schane 1984, 2005). After investigating the relevant data on the behavior of schwa, I will claim that English schwa should be represented by a single primitive feature [A]. This way of characterising schwa will, it is hoped, naturally reflect schwa’s status as an inherently weak vowel.

The organization of this chapter is as follows. Section 3.2 reviews the representation of schwa, which is assumed to be an empty structure in frameworks such as Element Theory (Backley 2011; cf. Harris 1994, Harris and Lindsey 1995), Dependency Phonology (Anderson and Ewen 1987; cf. Anderson and Jones 1974), Government Phonology (Kaye, Lowenstamm and Vergnaud 1985, 1990) and Particle Phonology (Schane 1984, 2005). In section 3.3, I consider in some detail a number of

phenomena in English involving vowel reduction. In order to identify what kind of structure is most appropriate for *a*, section 3.4 analyses phonological patterns observed in English such as vowel reduction and vowel epenthesis.

3.2. An unspecified representation

3.2.1. |A I U|-based models vs. Distinctive Feature Theory

A basic requirement for a system of segmental features is that it should distinguish all the segments in any one language (Rennison 1986). Furthermore, the system should characterise the phonological properties of individual segments and the relations holding between them, and should systematically account for phonological processes. Before talking about feature systems in detail, I will discuss why the theory posits the three ‘corner’ vowels as vocalic primitives.

Concerning typological frequency, the vowels which mark the corners of the vowel space, *a*, *i*, *u*, are the ones which most frequently occur in languages (Maddieson 1984). Although this higher typological frequency does not amount to absolute universality, it does indicate at least a strong tendency for the three corner vowels to be preferred cross-linguistically. This fact is acknowledged in several approaches to segmental phonology including Natural Phonology (Donegan 1978), Quantal Theory (Stevens 1972) and Dispersion Theory (Lindblom 1990). The implication is that these three vowels will constitute a maximally simple vowel system, with each one being specified by a unique, primitive unit of segmental structure.

In this study, I employ the |A I U| model of segmental representation, in which phonological primitives are privative (monovalent, single-valued). In a model based on

privativeness, a lexically contrastive property such as nasal (versus oral) is expressed in terms of the presence versus the absence of the nasal primitive [N]. Under this view, only the primitive that is present in a representation can be active in processes (such as nasal assimilation and nasal harmony), as shown in (1a). Its absence implies a failure to participate in phonological processes, as in (1b).

(1) a. Nasal assimilation

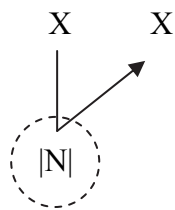

b. No process

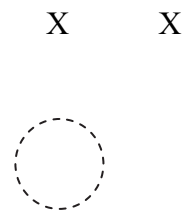

Compare this situation with an approach based on equipollence, which makes use of bivalent or two-valued features of the kind employed in most distinctive feature theories. Such a system makes it possible to refer to a larger number of grammars because it predicts a larger number of potentially active phonological properties. In the case of nasality, for example, we expect [+nasal] to be active, as in (2a), as well as [-nasal] as in (2b); we also make the prediction that both [+nasal] and [-nasal] could be active in the same language.

(2) a. Nasal assimilation

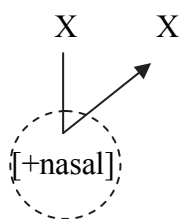

b. Nasal dissimilation

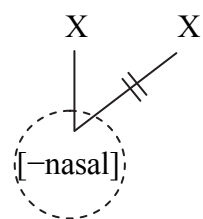

However, in the case of nasalization, only the prediction in (2a) is attested, whereas the other two predictions fail to be found in any language. Indeed, more generally the equipollent format substantially over-generates with respect to the number of unattested processes it can describe, especially when it is employed within a rule-based derivational mechanism.

Another area of concern with distinctive features¹ relates to the use of binary features such as [±high], [±low], [±back] and [±round] in the description of vowels. For example, the vowels *i* and *e* are represented as follows.

(3)

<i>i</i>	<i>e</i>
+high –low –back –round : :	–high –low –back –round : :

As their labels indicate, distinctive features are based on speech production: for example, [±high] and [±low] refer to the configuration of the tongue body. According to Kenstowicz (1994: 20), “each feature implies an independent phonetic dimension. Specification as plus or minus picks out a particular end point on the relevant dimension. The complete stock of features thus constitutes a hypothesis about the phonologically significant phonetic dimensions along which possible speech sounds can vary.”

¹ Distinctive features have their roots in the work of Roman Jakobson and his colleagues of the Prague School, these early feature-based models having made a significant contribution to the development of later (e.g., SPE) feature theories. One of the most significant achievements is that Distinctive Feature Theory allows us to consider phonological segments as feature matrices.

Combining two features generates three levels of vowel height: [+high, –low] (for high/narrow), [–high, –low] (for mid/narrow-open) and [–high, +low] (for low/open).

(4)

High	[+high] [–low]	i:	ɪ			u:	ʊ
Mid	[–high] [–low]		e	ɜ:	ə	ɔ:	
Low	[–high] [+low]		æ	ɑ:	ʌ		ɒ

Notice that another logically possible combination exists, [+high, +low], the realisation of which is physically impossible since the tongue body cannot be located in a high and a low position simultaneously. Thus Distinctive Feature Theory produces many unwanted combinations, creating the need for particular constraints designed to exclude illicit combinations such as [+high, +low]. The overall effect is to weaken the theoretical restrictiveness of the approach.

3.2.2. Empty structure in vowel representations

3.2.2.1. Element Theory (Backley 2011)

Earlier studies of the vowel schwa generally focused on the idea that it should be regarded as the most unmarked vowel which lacks any significant properties in terms of either speech production or speech perception. There have been many attempts to identify the phonological structure of schwa in various theories of phonological representation, among which I discuss the representation of schwa in the |A I U| model of melodic representation, as employed in Element Theory (Backley 2011; cf. Harris 1994; Harris

and Lindsey 1995), Dependency Phonology (Anderson and Ewen 1987; cf. Anderson and Jones 1974), Government Phonology (Kaye, Lowenstamm and Vergnaud 1985, 1990) and Particle Phonology in (Schane 1984, 2005). Common to these models is the assumption that schwa has no salient properties, although the types and the functions of the primitive units they employ are different between one approach and another.

First consider Element Theory (Harris 1994; Harris and Lindsey 1995). This theory assumes three vocalic primitives, which are referred to as *elements*, and denoted by |A|, |I| and |U| (called *mAss*, *dIp* and *rUmp* respectively). These three elements are independently interpretable and phonetically manifest themselves as the vowels *a*, *i* and *u* respectively. As illustrated below, these sounds correspond to acoustic patterns which derive their uniqueness from their different patterns of energy distribution, each one corresponding to a different pattern of energy peaks created by converging formants. Unlike *a*, *i* and *u*, schwa (*ə*) shows an acoustic pattern with equally spaced spectral peaks, i.e., no converging formants. The respective patterns are illustrated in (5), shown as a spectral cross-section on the left hand side and a spectrogram on the right hand side (from Backley 2011).

(5) a. Spectral pattern and spectrogram of *a*:

a single peak in the middle part of the spectrum; a peak formed by the convergence of F1 and F2

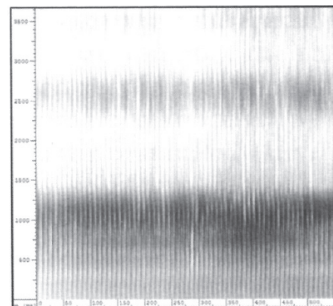
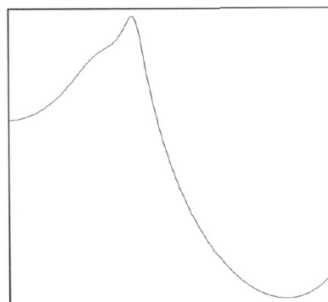

b. Spectral pattern and spectrogram of *i*:

two energy peaks with an intervening dip; a low peak of first formant (F1) and a high peak formed by the convergence of two formants (F2 and F3)

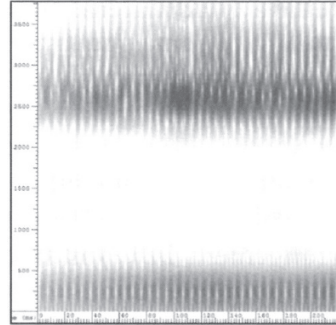
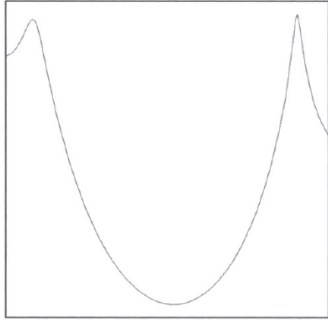

c. Spectral pattern and spectrogram of *u*:

a concentration of energy at lower frequencies; a low peak with the convergence of F1 and F2 and rapid reduction in acoustic energy

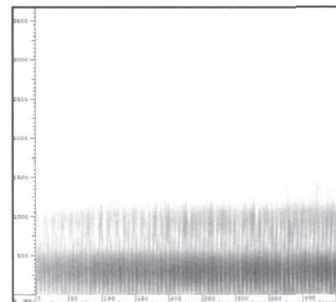
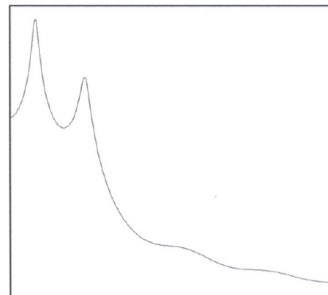

d. Spectral pattern and spectrogram of *a*

regularly dispersed formant peaks; no prominent peaks and no convergence of formants

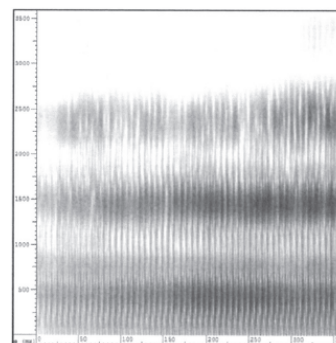
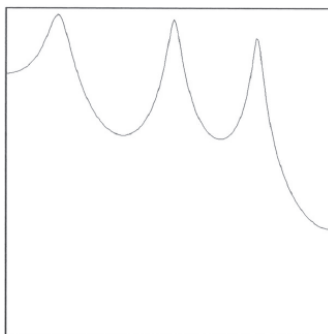

The spectral shapes in (5abc) are used by both speakers and listeners to produce and perceive vowel sounds. On the other hand, the spectral pattern in (5d) with evenly spaced spectral peaks lacks the kind of salient linguistic information which is transmitted between speakers and listeners during communication.

According to the version of Element Theory described in Harris (1994), vocalic resonance is represented the three standard resonance elements |A| (mAss), |I| (dIp) and |U| (rUmp) *and* also by |@| – a neutral (or ‘identity’) element which bears no positive linguistic properties. The four vowel elements |A|, |I|, |U| and |@| have acoustic profiles which correspond to the patterns in (5a), (5b), (5c) and (5d) respectively. According to Harris and Lindsey (2000), these elements are primarily internal objects or mental images of linguistically significant information; at the same time, however, they are also to be seen as external objects or physical patterns in the speech signal which listeners use to cue those mental images (Nasukawa and Backley 2008: 37).

As mentioned earlier, elements are phonetically interpretable without the support of other elements² and without the need for additional (e.g., redundant) information to be supplied by the grammar. When the elements |A|, |I|, and |U| appear individually in a nuclear position, they are phonetically realised as low *a*, front *i* and back rounded *u*, respectively. However, most segments are in fact formed by a combination of elements. The compound expressions |A I| and |A U|, for example, are phonetically interpreted as *e* and *o* respectively. Each compound expression results in an acoustic signal characterised by multiple acoustic patterns, as illustrated below.

² Harris and Lindsey (1995) call this the ‘autonomous interpretation hypothesis’.

(6) a. |A I| *e*

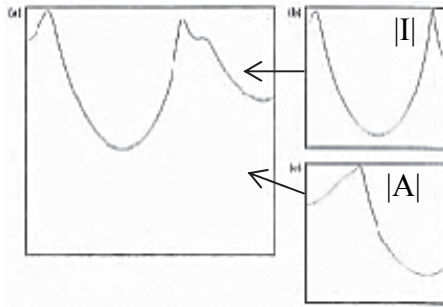

b. |A U| *o*

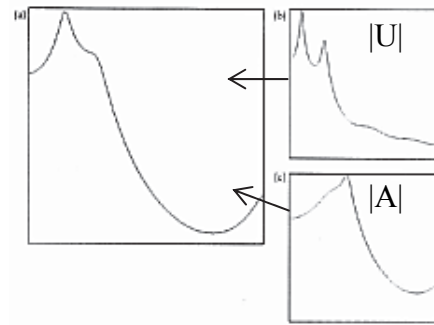

In addition to a simple combination of elements, some compound expressions may display asymmetric relations between elements. This is typically defined in terms of dependency or headedness.³ The theory prescribes that an element can be phonetically more prominent than other accompanying (dependent) elements if it is the head of a compound expression. Consider a language which contrasts the high-mid vowels *e* and the low-mid vowels *æ*, both of which consist of the elements |A| and |I|. In this case, the two elements are assumed to enter into a dependency relation. When |I| is structurally dominant over |A|, the expression is phonetically realised as the high-mid vowel *e*, since the acoustic pattern for the headed |I| is considered to be stronger than that for the dependent |A|. On the other hand, an expression consisting of a headed |A| and a dependent |I| is phonetically interpreted as the low-mid vowel *æ*, since the acoustic pattern for the headed |A| is considered to be more prominent than that for |I|. These are represented below (heads are underlined).

³ This notion comes originally from Dependency Phonology.

- (7)
- | | | |
|----|----------|--------------|
| a. | <i>e</i> | A, I |
| b. | <i>æ</i> | <u>A</u> , I |
| c. | <i>o</i> | A, <u>U</u> |
| d. | <i>ɒ</i> | <u>A</u> , U |

As shown above, the structural difference between *o* and *ɒ* is also accounted for in the same way as discussed for the representations of *e* and *æ*: as for *o*, the acoustic pattern for the headed |U| is stronger than that for the dependent |A| while regarding *ɒ*, the acoustic pattern for the headed |A| is more prominent than that for the dependent |I|.

In earlier versions of Element Theory, as discussed in the previous chapter, *ə* is assumed to be the phonetic manifestation of an empty nucleus (Charette 1991; Harris 1994, 2005; Harris and Lindsey 1995, 2000) – that is, a nucleus which has no lexically specified melodic content. In Element Theory, a melodically unspecified nucleus is symbolized by |@| (Harris 1994, Harris and Lindsey 1995). In some recent work (Harris 2005) the symbol |@| has been replaced simply by a gap | |.

- (8) *ə* |@/| |

It is natural that the structure for *ə* is represented with no reference to |A|, |I| and |U| because they have salient properties which are absent from *ə*. According to Harris (1994) and Harris and Lindsey (1995), the independent phonetic manifestation of |@| may be assumed to cover the non-peripheral areas of the vowel triangle in (4), which is non-open, non-palatal and non-labial.

(9)

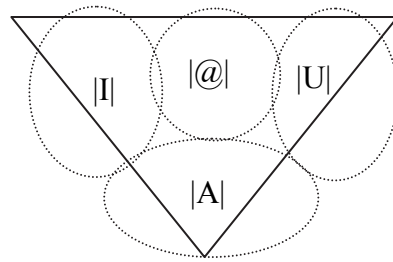

Sounds corresponding to the central area show no distinct acoustic pattern, though they are associated with a certain resonance baseline. Harris and Lindsey (1995, 2000) assume that the baseline symbolized by |@| is latently present in all vowel segments, and once other vocalic elements are superimposed onto it, |@| fails to be perceptible. Figuratively speaking, the baseline may be thought of as a blank canvas onto which the colors represented by |A|, |I| and |U| can be painted.

Although schwa is considered to be the phonetic manifestation of a melodically empty nuclear position in some versions of Element Theory, an approach proposed by Backley (2011) deserves special mention in our discussion of schwa. Backley (2011) presents a representation for schwa in RP English in a way that differs from other approaches: he claims that weak vowels are specified by the non-headed expressions shown in (10).

- (10)
- | | |
|----------|---|
| <i>ə</i> | A |
| <i>ɪ</i> | I |
| <i>ʊ</i> | U |
| <i>ɨ</i> | |

Here, schwa is represented by a single element |A|. ⁴ Moreover, he proposes that an expression which is structurally empty is phonetically realised as *i*, which is therefore distinguishable from schwa structurally.

Backley (2011: 33) mentions that in a system where schwa ə contrasts lexically with another central vowel such as *i* in RP English, one must be represented by a melodically-empty expression while the other should have an element in its structure. Harris (1994: 110) also points out the fact that some dialects of English have the relatively open vowel *e*, which is often transcribed as ə but is phonetically distinct from it on the (in standard articulatory terms) height dimension. Several pairs of English words can be found to highlight the difference in question, such as ‘*Rosa’s*’ versus ‘*roses*’, where the weak vowel in ‘*Rosa’s*’ is realised as ə and has the structure |A, @| while the weak vowel in ‘*roses*’ is pronounced as *i*, which is featureless and thus represented by |@|.

3.2.2.2. Dependency Phonology (Anderson and Ewen 1987)

The research program known as Dependency Phonology originated in Anderson and Jones (1974) and subsequently developed in Lass (1984) and Anderson and Ewen (1987). Its proposals for the set of phonological primitives in vowel representations are mostly shared with Government Phonology, Element Theory and Particle Phonology: the primitives employed in these related frameworks define privative oppositions based on the presence versus the absence of particular properties, so that a segment may consist

⁴ Following Kaye, Lowenstamm and Vergnaud (1985), Broadbent (1991) also gives an analysis for linking and intrusive *r* in English. Using an Element Theory approach, she proposes that schwa roughly consists of |A, v|, where the element |A| as an operator combines with the most unmarked element |v| as a head.

either of primitives in combination or a single primitive in isolation. Harris (1994) describes a primitive as being ‘smaller than a segment, but big enough to phonetically manifest itself’. Within Dependency Phonology and the other theories just mentioned, only a primitive which is present in a representation can be accessed by the grammar and participate in a phonological process.

As the name suggests, another central concept of Dependency Phonology is the notion of dependency: that is, head-dependent relations between primitives within a given structure. This notion applies throughout phonological structure, both prosodic and segmental. In the framework of Dependency Phonology, a compound expression involves a preponderance of one component over another, such that (i) α dominates β , (ii) β is dominated by α , and (iii) α and β are mutually dependent.⁵ In effect, this concept not only accounts for tense/lax contrasts but is also responsible for creating a variety of (finely distinguished) vocalic contrasts.

Dependency Phonology posits three primitives called *components*: $|a|$, $|i|$ and $|u|$ which are defined traditionally as “openness/sonority”, “palatality” and “roundness” respectively. They are based on salient vocalic properties which refer to both speech production and perception. For example, a typical seven-vowel system is illustrated in (11):

(11)	<i>i</i>		<i>u</i>	$ i $		$ u $
	<i>e</i>		<i>o</i>	$ i\Rightarrow a $		$ u\Leftarrow a $
	<i>ɛ</i>	<i>ɔ</i>		$ a\Rightarrow i $	$ a\Leftarrow u $	
		<i>a</i>		$ a $		

⁵ In Anderson and Ewen (1987), ‘government’ is equated with ‘preponderate over’, in other words ‘dependency’.

Dependency Phonology assumes a specific component for centrality, denoted as |ə| (the centrality component), which is used to represent schwa (or any phonologically neutral, phonetically central variant of schwa).

(12) ə |ə|

This fourth vocalic component has the status of a phonological primitive, but one which lacks any salient articulatory properties.

3.2.2.3. Government Phonology (Kaye, Lowenstamm and Vergnaud 1985)

Government Phonology began with the publication of Kaye, Lowenstamm and Vergnaud (1985), which investigated aspects of prosodic constituent (syllable) structure. It was later extended to the study of segmental representations, sharing some conceptual foundations with Dependency Phonology and Particle Phonology since Government Phonology also assumes three elements [A I U] for vocalic expressions. Again, each element is assumed to be interpretable either autonomously or jointly.

Note, however, that according to Kaye, Lowenstamm and Vergnaud (1985: 311), the representational system of Government Phonology should not be treated as “a sort of unary feature system. The ultimate constituents of segments are *not* features, binary, unary or other. They are autonomous pronounceable elements defined as fully specified feature matrices.” They also claim that phonological features may not be accessed directly or manipulated by the grammar; rather, their role is to serve as the material for the phonetic interpretation of phonological segments. Following Vergnaud (1982), Kaye, Lowenstamm and Vergnaud discuss the definition of the three vocalic elements by

‘translating’ them into SPE-type distinctive features.

(13)	I	U	A	v
	<u>-ROUND</u> <u>-BACK</u> +HIGH -ATR -low	<u>+ROUND</u> +BACK +HIGH -ATR -low	<u>-ROUND</u> +BACK <u>-HIGH</u> -ATR +low	<u>-ROUND</u> +BACK +HIGH -ATR -low

The underlined features in each expression are considered to be marked values, which are called *hot* features that define the salient property of an element. Meanwhile, the expression denoted by ‘v’ is referred to as the *cold* vowel, a melodic object without any hot features. In terms of representation, the cold vowel potentially occupies ‘empty’ positions, as illustrated in (14).

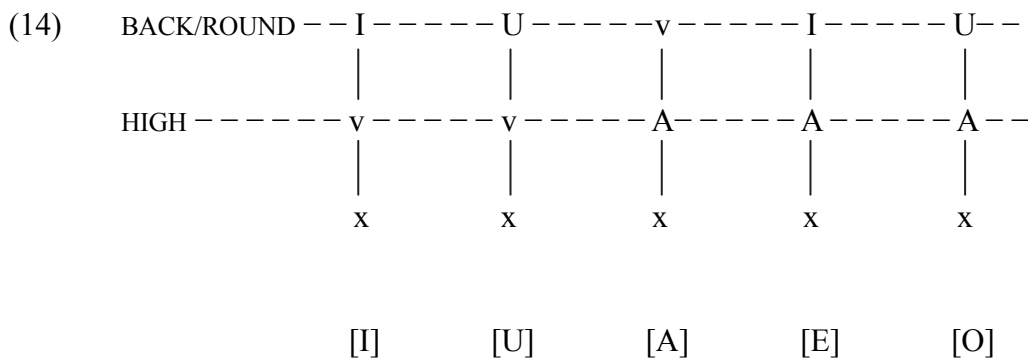

The horizontal lines labelled ‘BACK/ROUND’ and ‘HIGH’ are tiers which are originally assumed in Autosegmental Phonology (Goldsmith 1979, 1990). These lines are required to associate each element with its marked value and with a particular x-position.

Kaye, Lowenstamm and Vergnaud (1985) examine the vowel system of Kpokolo, an eastern Kru language spoken in the canton of Kpokolo in the Ivory Coast. Kpokolo

has a rich vowel inventory and has no less than four central vowels: the ATR high central *i*, the RTR high central *ɨ*, the RTR mid central *ɜ*, the ATR mid central *ə*).

(15)

	[-ATR]			[+ATR]		
high	ɪ	ɨ	ʊ	ɪ	ɨ	u
mid	ɛ	ɜ	ɔ	e	ə	o
low		a				

Contrasts among the central vowels (*i*, *ɨ*, *ɜ*, *ə*) are illustrated in (16), where the feature [ATR] is active and [+ATR] is represented using a separate ATR element ‘ɸ’.

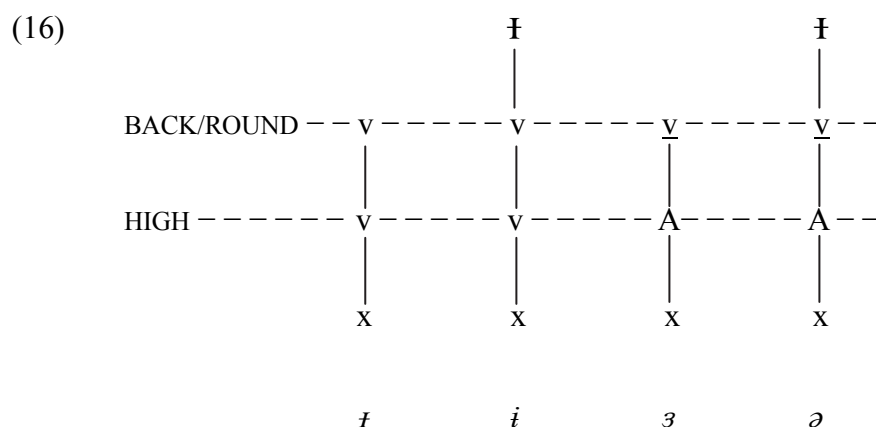

As shown above, ATR-ness is represented by the presence of |ɸ| and RTR-ness by the absence of |ɸ|. Regarding the degree of height, the absence of |A| denotes high vowels while the presence of |A| indicates non-high vowels. As described earlier, mid vowels are represented by a combination of |A| and the headed |v|. (cf., a combination of |A| and the non-headed |v| is phonetically interpreted as low *a*.)

3.2.2.4. Particle Phonology (Schane 2005)

Particle Phonology also has its origins in Anderson and Jones (1974) but was then developed by Schane (1984, 2005). In this theory, phonological primitives for vowels are proposed on the basis of the same tenets that apply in Element Theory, Dependency Phonology and Government Phonology: for convenience, it is repeated that primitives which are employed in these theories are defined in terms of privative oppositions (presence versus absence), so that a segment may comprise not only a combination of primitives but also a single primitive on its own.

Particle Phonology also employs three vocalic primitives, which are referred to as *particles* and denoted by the labels |a|, |i| and |u|. Unlike elements, particles are defined in terms of articulation rather than perception. The three particles |a| |i| |u| are independently interpretable and phonetically manifest themselves as *a*, *i* and *u* respectively. The particles can also combine to form melodic compounds: for instance, *e* and *o* are represented by |a i| and |a u|, respectively.

According to Schane (2005), particles correspond to three broad phonological traits. Specifically, |a| corresponds to aperture or openness, |i| to palatality or frontness, and |u| to labiality or roundness. These are schematized as follows:

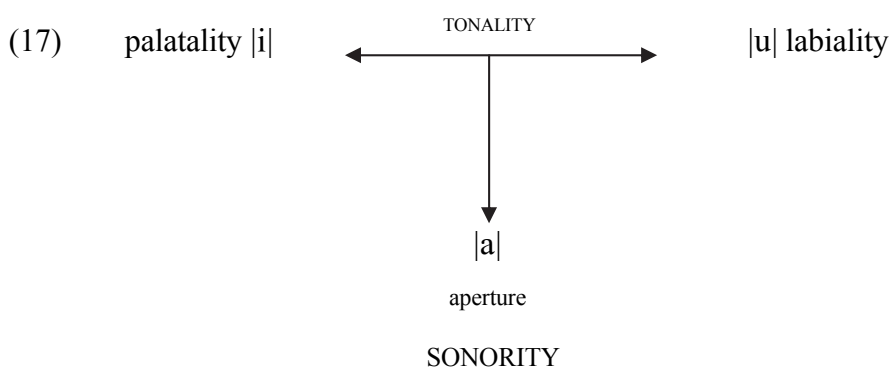

A key concept in Particle Phonology is that the three primitives are not equal in their ability to co-occur: only the particle |a| is allowed to appear more than once in a single position. Markedness is encoded directly in the number of tokens of |a| in a structure.⁶ With these particles, Schane (2005: 321) represents the front vowels of English as follows:

(18) The front unrounded vowels of Standard English in Particle Phonology⁷

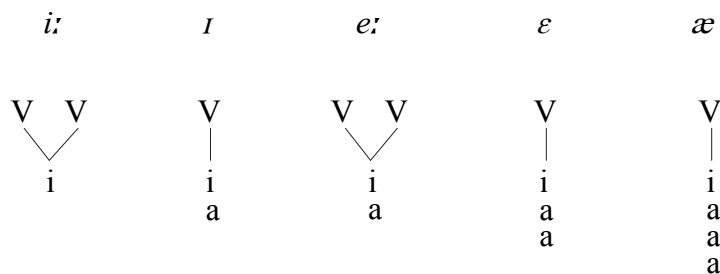

(V = vocalic position)

Notice that in the representations in (18), the aperture particle |a| has a special status: it is the only particle that can be duplicated in a single position. The multiple occurrence of the aperture particle expresses not only the degree of height (openness) but also the

⁶ It is an open question as to whether multiple occurrences of the aperture particle succeeds in representing the special status of the particle |a|. As observed in Schane (2005), the particle |a| is unique in terms of its three inherent properties: lowered height, centralization and retracted tongue root. In this paper, this uniqueness is conveyed by the representational constraint that only the aperture particle can occur more than once in a single expression: multiple occurrences of |a| increase the degree of low vowel height and retracted tongue root while a single |a| denotes centralization.

⁷ Schane (2005) assumes that Standard English has five front unrounded vowels, as shown in (18), two central vowels *ɜ* and *ɝ*, five back unrounded vowels, *ɔ*, *u:*, *o:*, *ɔ* and *ɔ:*, and a reduced central vowel *ə*.

laxness of vowels.⁸ To take a case in point, English has a tense/lax distinction in the phonological system which is reflected phonetically in different qualities. The vowels *ɪ* and *eɪ* in (18), for instance, have the same particle composition, but the aperture particle phonetically manifests as laxness for *ɪ* and as lowered height for *eɪ*. One of the aperture particles of *ɛ* and *æ* denotes laxness and the other(s) lowered height.⁹

In this model of melodic representation, the least marked vowel *ə* is represented by the absence of any particle. This is illustrated as follows:

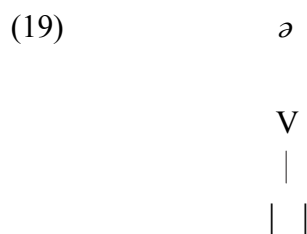

Schane (2005: 331) proposes that English schwa (the central reduced vowel) contains no particles in its structure because Particle Phonology sees the process of vowel reduction as involving a loss of all particles from a vocalic expression.

3.2.3. Phonological emptiness and its phonetic realisation

The representational models presented in the preceding subsections are indeed similar to each other in that all vowels may be represented by referring to three basic units, such as

⁸ In other languages, they also encode differing degrees of retraction of the tongue body.

⁹ Schane (1984, 2005) assumes the Law of Maximum Aperture, which requires that the central vowel *a* has the same number of aperture particles as the lowest tonality vowels in a given language. This adjustment accommodates the possible interaction of *a* with other tonality particles.

|A I U| or |a i u|. For the sake of comparison, I repeat the representations for the most unmarked vowel, schwa.¹⁰

¹⁰ In Distinctive Feature Theory, the segments *e* and *ə* may be represented as follows:

<p>i. <i>e</i></p> <div style="border-left: 1px solid black; border-right: 1px solid black; padding: 0 10px; margin-left: 40px;"> <p>–high</p> <p>–low</p> <p>–back</p> <p>–round</p> <p style="text-align: center;">:</p> <p style="text-align: center;">:</p> </div>	<p>ii. <i>ə</i></p> <div style="border-left: 1px solid black; border-right: 1px solid black; padding: 0 10px; margin-left: 40px;"> <p>–high</p> <p>–low</p> <p>+back</p> <p>–round</p> <p style="text-align: center;">:</p> <p style="text-align: center;">:</p> </div>
---	---

As for the specification of schwa, there seems to be no consensus on which feature is marked with ‘+’ (cf. Kaye, Lowenstamm and Vergnaud 1985, Harris 2005, van der Hulst 1988: 210, Carr 1993: 64). The specification given in (ii) is due to Kaye, Lowenstamm and Vergnaud (1985: 310) and Harris (2005: 128).

In (i), the vowel *e* is phonetically realised by keeping the tongue body at the neutral point and avoiding any retraction of the tongue body or lip-rounding. On the other hand, in (ii), the vowel *ə* is articulated in the same way as *e*, except that tongue retraction does take place. In comparison with other vowels, schwa tends to appear in contexts of neutralisation, which prefer less marked vowels to more marked ones. However, the feature value specification of (i) and (ii) falls through since *e* and *ə* are equally marked in terms of the number of features they contain. Moreover, the specification might wrongly imply that *e* is less marked than *ə* with respect to the feature [–back], if the negative value is translated as ‘unmarked’ (as in SPE). This specification fails to show the characteristics of schwa which have been discussed in the previous chapter.

- (20)
- a. Element Theory |@/| |
 - b. Dependency Phonology |ə|
 - c. Government Phonology v
 - d. Particle Phonology | |

As we can see, these models adopt an empty expression to describe the absence of salient properties in a vowel.

It should be noted that a particular position which has no primitive does not need to be phonetically silent. Like primitives (features), syllable constituents such as onsets and nuclei are phonetically interpretable since phonological categories of any kind must, in nature, be interpreted by the Articulatory-Perceptual systems which interface with the phonological component. In the case of an empty nucleus, it is often considered to be realised as a schwa-like central vowel. Under this view, Government Phonology allows an empty nucleus to be phonetically realised if it is not p-licensed ((10) in chapter 2). On the other hand, if an empty nucleus is p-licensed by virtue of Proper Government, the Domain-final-empty-nucleus Parameter, or the Magic licensing Parameter (section 2.3.2 in chapter 2), it is permitted to be phonetically silent.

With this in mind, the next question is whether an empty structure is truly appropriate for characterising schwa. In the following section, I will focus on the distributional properties of English schwa along with some related data.

3.3. Schwa

3.3.1. Characterising schwa

Before considering some distributional patterns of English schwa, I review some general characteristics of schwa-like vowels. According to Backley (2011), we find schwa-like vowels in many vowel systems, no matter what their shape or size. Examples of vowel systems which employ a schwa-like vowel are given below.

(21) Backley (2011: 31)

[a i u] + [ə]	Wapishana
[a i u ε ɔ] + [ə]	Chukchi
[æ ɪ ʊ e ɒ ʌ] + [ə]	RP English (short vowels)
[a i u e o ε ɔ] + [ə]	Wolof
[a i u e o ü ö] + [i]	Turkish
[a i u e o ε ɔ ɪ ʊ] + [ə]	Bari

(Vowel length and nasality are omitted.)

In the above systems, schwa and schwa-like vowels appear as a reduced/weak vowel in phonologically weak contexts such as unstressed positions. Because of this, schwa is typically not included as a member of the phoneme inventory in any given language. This is also true in English, as schwa typically appears in contexts where all vowel contrasts are suspended (Giegerich 1992).

We have been following the convention of denoting schwa-like vowels using the various symbols *ə*, *ɨ* and *ʉ*. Indeed, Chomsky and Halle (1968: 110) note that “the exact

phonetic realisation of ə does not concern”, as the symbols cover phonetically vague qualities whereas other symbols such as *a*, *i* and *u* indicate relatively stable phonetic qualities. As illustrated in (22), in terms of the traditional vowel triangle these different schwa-like symbols all refer to the central region of the vowel space.

(22)

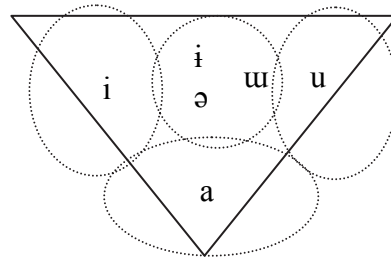

Depending on the language, ə (or *i*, *u*) indicates varying degrees of openness, backness and roundedness (Harris and Lindsey 1995). For example, in the transcription of Catalan, it corresponds to a relatively open value, in Moroccan Arabic a relatively close value, and in French a front rounded quality. Although there are a few phonetic differences from system to system, the sound symbolized by ə is mainly produced by an articulation in which the supra-laryngeal vocal tract configuration adopts a neutral position and a fairly uniform (tube-like) shape (Harris 1994, Harris and Lindsey 1995).

In relation to the articulatory vowel space, a schwa-like vowel roughly corresponds to a fairly central position. More precisely, in speech production terms it requires minimal effort to produce, and requires the articulators to assume a neutral setting. English schwa is produced with the setting of a non-high, non-low, non-front, non-back articulatory position. That makes schwa’s phonetic identity variable; with regard to the phonetic quality of schwa, it slightly varies from language to language and from dialect to dialect (Giegerich 1992). In addition, Flemming (2007) investigates the variability of schwa in terms of its distribution. In the case of English, Flemming (2007)

finds that one factor of the variability of word-medial schwa is its short duration, which makes schwa assimilate to any surrounding sounds.

A general distributional property of schwa-like vowels is that they manifest themselves as reduced or neutralised reflexes in unstressed positions. As mentioned above, these vowels do not have a definite phonetic quality since it encompasses a set of phonetic realisations that are phonetically diverse. This is because unstressed positions are phonologically weak, which means that those positions can carry less linguistic information than stressed positions. In other words, unstressed positions have a lesser ability to display contrasts than stressed positions have. Therefore, as vowels weaken in unstressed positions they lose their ability to express vocalic contrasts, then ultimately, neutralise or reduce to a weak vowel, which is typically schwa.

3.3.2. Distributional patterns of English schwa

In terms of phonological distribution, there seem to be three different kinds of schwa.¹¹ First, there is a lexically-specified schwa, which does not alternate with other vowels (e.g., *əbaʊt* ‘about’, *aɪdi.ə* ‘idea’). Second, another type of schwa behaves as an epenthetic or intrusive vowel, as observed in English inflected forms such as *ʃɪdʒɪz* ‘judges’ and *blendəd* ‘blended’ (especially in dialects spoken in North America). Third, another type of schwa may appear as a result of vowel reduction (e.g., *ˈætəm* ‘atom’ > *əˈtɒmɪk* ‘atomic’).

¹¹ Along similar lines, van Oostendorp (2003) claims that schwa in Dutch may be characterised as having three types: that is, *e*-schwa (epenthetic), *r*-schwa (reduction) and *u*-schwa (underlying, non-alternating).

The first type of schwa in the above classification, that is, a lexically-specified schwa, may appear in any context: word-initially (*ə*'*nɔɪ* 'annoy', *ə*'*b'teɪn* 'obtain'), word-medially (*sə*'*pəʊz* 'suppose', '*prɒbə*'*b'l* 'probable') and word-finally ('*səʊfə* 'sofa', '*kɒm*'*ə* 'comma'). According to Flemming and Johnson (2007), there are significant phonetic differences between schwa in word-final position and schwa in other contexts. They find that schwa in a word-final syllable has a relatively stable vowel quality, mid-central in most cases, while schwa in a word-internal syllable is relatively high and varies in backness and lip position depending on its context. This can be seen from the figure in (23).

(23)

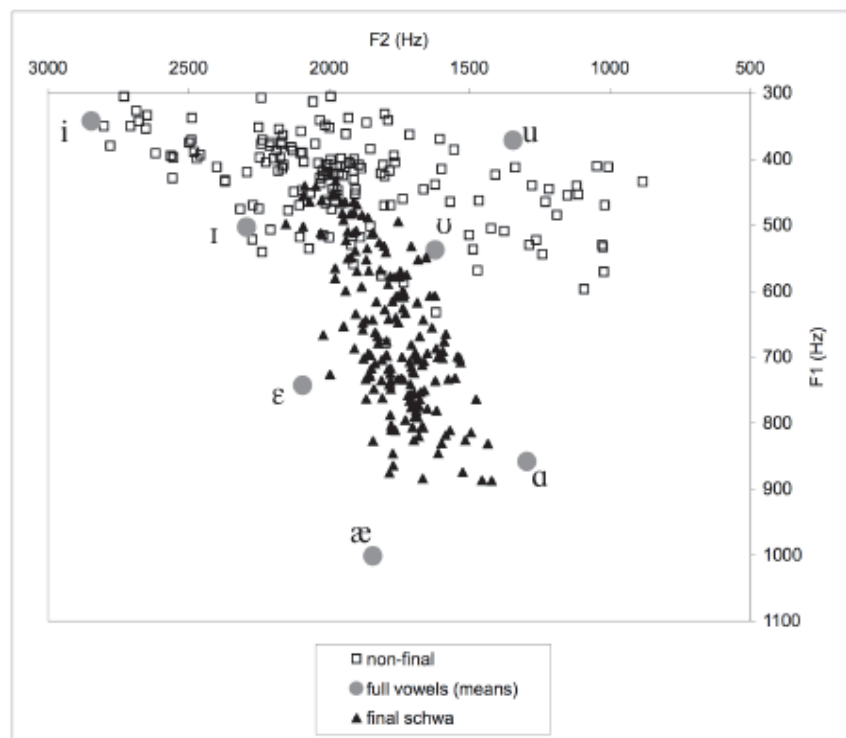

Formant frequencies of tokens of final schwa (filled triangles) and non-final schwa (open squares), and the mean formant frequencies of the full vowels (gray circles). Data from nine female speakers of American English. (Flemming 2009)

With regard to this, Silverman (2004) points out that “[t]his variability is usually a consequence of schwa’s context: flanking consonants and vowels may have a significant co-articulatory influence on schwa’s phonetic starting and ending postures”.

As for the second type of schwa, in non-rhotic dialects of English (typically in RP) we can often find that schwa is contrastive with other vowels in unstressed syllables, as in *'betə* ‘better’ versus *'beti* ‘Betty’ or the inflected forms *'pɪtʃəz* ‘pitchers’ versus *'pɪtʃɪz* ‘pitches’ and *'fætəd* ‘chattered’ versus *'fætɪd* ‘chatted’ (Bacley 2011, Cruttenden 2008).

(24) Contrasts between ə and ɪ/i (or ɨ) in unstressed syllables

a. *better* vs. *Betty*, *batter* vs. *batty*, *affect* vs. *effect*, *accept* vs. *except*

b. *pitchers* vs. *pitches*, *chattered* vs. *chatted*

3.3.3. Alternation between full vowels and schwa

As mentioned above, the third type of schwa results from vowel reduction in unstressed syllables. In English, we can observe a set of full vowels in stressed syllables; in unstressed syllables the range of vowel contrasts is severely restricted. Now let us look at the data of vowel reduction.

As for some words, we distinguish verbs and nouns/adjectives by looking at the difference of stress placement. The verb-noun/adjective pairs in (20) show alternations between full vowels and schwa which are caused by stress shift.

(25) a. Short vowels

e frequent [fri'kwɛnt]_V – [fri:kwənt]_{ADJ}
segment [seg'mɛnt]_V – [segmənt]_N

æ addict [ə'dɪkt]_V – [ædɪkt]_N
traverse [trə'vɜːs]_V – [trævɜːs]_{N/ADJ}

ʌ subject [səb'dʒekt]_V – [sʌbdʒɪkt]_{N/ADJ}
suspect [sə'spekt]_V – [sʌspekt]_{N/ADJ}

ɒ/a compound [kəm'pɑund]_V – [kɒmpɑund]_{N/ADJ}
object [ub'dʒekt]_V – [ubbdʒekt]_N
convoy (Am.) ['kɑnvɔɪ]_V – [kən'vɔɪ]_N

b. Long vowels and diphthongs

ɜː survey [sə'veɪ]_V – [sɜːveɪ]_N
perfect [pə'fekt]_V – [pɜːfikt]_{N/Adj}

aɪ digest [də'dʒest]_V – [daɪdʒest]_N

əʊ progress [prəg'res]_V – [prəʊgres]_N
protest [prə'tɛst]_V – [prəʊtɛst]_N

Some other verb-noun pairs include those which do not show vowel alternation, as in (26).

- (26) discount [dɪs'kaʊnt]_V– [dɪskaʊnt]_N
 abstract [æb'strækt]_V– [æbstrækt]_N

Moreover, there are words that may alternate with not only *ə* but also *ɪ*.

- (27) research [rɪ'sɜ:tʃ]_V– [ri:sɜ:tʃ]_N
 escort [ɪ'skɔ:t]_V– [eskɔ:t]_N
 defect [dɪ'fekt]_V– [di:fekt]_N

Notice that there are some other vowels which show no vowel alternation with *ə*, as shown below:

(28) Verb-Noun/Adjective pairs

- | | | |
|----------------------|----------|---|
| <i>i:</i> – <i>ɪ</i> | eject | [ɪ'dʒekt] _V – [i:dʒekt] _N |
| | decrease | [dɪ'kri:s] _V – [di:kri:s] _N |
| | regress | [rɪ'ɡres] _V – [ri:ɡres] _N |
| | retard | [rɪ'tɑ:d] _V – [ri:tɑ:d] _N |

Vowel alternation in (28) takes place between the tense (full) vowel *i:* and the lax (reduced) vowel *ɪ*; in other words, the alternation from *i:* to *ɪ* is described straightforwardly as a loss of length, peripheral position, and stress.¹²

¹² Some other English words also exhibit no vowel reduction (e.g., [ɑ:'senɪk]_{Adj} ~ [ɑ:snɪk]_N 'arsenic', [kən'sɔ:t]_V ~ [kɒnsɔ:t]_N 'consort'), which may be explained in morphological terms. This is beyond the scope of the present discussion.

Now let us look at another case of vowel reduction, which is related to suffixation. In some word-formation processes, the addition of a suffix brings about stress-shift which results in a change to the stress pattern of the word's base. Stress shift involves a reduction process which changes a full vowel into its reduced reflex. As shown in (24), vowels which lose a primary stress typically alternate with schwa.

(29) a. Short vowels

e – ə fragment (v.) – fragmentation [fræg'ment] – [frægmə'n'teɪʃən]

æ – ə magic – magician ['mædʒɪk] – [mə'dʒɪʃən]
 academy – academic [ə'kædəmi] – [ækə'demɪk]

ʌ – ə productive – productivity [prə'dʌktɪv] – [prɒdʌk'tɪvəti]

b. Diphthongs

aɪ – ə admire – admiration [əd'maɪə] – [ædmə'reɪʃən]

eɪ – ə native – nativity ['neɪtɪv] – [nə'tɪvəti]

əʊ – ə progress – progressive ['prəʊɡres] – [prə'ɡresɪv]

eə – ə parent – parental ['peərənt] – [pə'rentl]

Again, as in shown in (30), there are some vowels which do not alternate with schwa. The vowels in (30) show an alternation between tense (full) vowels and lax

(reduced/weak) vowels.

- (30) *u:* – *ʊ* compute – computation [kəm'pju:t] – [kɒmpjʊ'teɪʃən]
 repute – reputation [rɪ'pju:t] – [repjʊ'teɪʃən]

The expected effect is a neutralisation of contrasts between vocalic segments, the process coming under the general label of vowel reduction. In this process, peripheral vowels are typically neutralised and reduced to a central vowel (ə). In describing vowel reduction, Chomsky and Halle (1968: 110) note how “lax vowels reduce to a central, high, or mid unrounded ‘neutral’ vowel in English when they are sufficiently weakly stressed.” They formulate the process as in (31):

$$(31) \quad \begin{array}{c} \boxed{\begin{array}{l} \text{–stress} \\ \text{–tense} \end{array}} \\ \text{V} \end{array} \rightarrow \text{ə}$$

The rule in (31) states that in unstressed syllables vowels which lose their (primary or secondary) stress and tenseness reduce to schwa. However, as observed above, it is not the case that all types of full vowels reduce to schwa: for example, vowel reduction to schwa does not affect the vowels *i:* and *u:*; in languages with vowel reduction the tendency is for the high vowels to be immune to reduction effects.¹³

¹³ Further evidence in support of this position comes from Harris (2005), where it is shown that vowel reduction is of two different types: centrifugal and centripetal. In the centrifugal pattern, vowels reduce in the direction of the corner vowels *a*, *i* and *u*, as exemplified in Belorussian:

Thus far, using the examples in (25)–(30) I have described some of the properties of schwa in relation to the contexts in which vowel reduction takes place. To characterise the nature of schwa and explain my findings, the next section reviews the representation of ə.

i. Belorussian

Strong	i	e	a	o	u
Weak	i		a		u

By contrast, in the centripetal pattern vowels reduce by moving towards the central region of the vowel space, as in Bulgarian:

ii. Bulgarian

Strong	i	e	a	o	u
Weak	i		ə		u

Let us again suppose that the internal structure of schwa is the just the sole particle |a|. If so, then the quality of the reduced vowel is predictable from its full vowel counterpart in both the centrifugal and centripetal systems. Clearly, the data suggests that the melodic representation of the original vowel helps determine the choice between ə and ɪ.

3.4. Representing English schwa

3.4.1. Vowel reduction

This section considers the representation of English vowels using an Element Theory approach. It is reasonable to suppose that Element Theory is appropriate for describing vowels, given that markedness is expressed directly in element representations – in sharp contrast to Distinctive Feature Theory, which employs equipollent features. While an equipollent feature is entirely dependent on the presence of other features (in the same feature matrix) before its unique properties can be expressed, the three elements |A|, |I| and |U| are phonetically interpreted as *a*, *i* and *u* independently of all other units.

Linguistic strength may be seen as a function of the relation between stress placement and vowel distribution. According to Backley (2011: 50), “[b]ecause full vowels are linguistically strong (contrastive) and acoustically strong (headed), they can appear in strong (stressed) syllables. On the other hand, weak vowels are linguistically weak (non-contrastive) and acoustically weak (non-headed), so they are limited to weak (unstressed) syllables.” From a phonetic point of view, vowel reduction is viewed as a process where full vowels alternate with reduced vowels in unstressed positions; in other words, the result is a qualitative alternation. Why, then, does vowel alternation typically produce ə (not *ɪ*)? And what is the nature of the relation between full vowels and schwa? The alternation in question, from segmental point of view, is a compositional interchange of elements. To clarify the issue, I will explore the interrelation between unreduced and reduced vowels in more detail.

According to Backley (2011), and as we have seen in section 3.3, alternations with schwa reveal that all of the full vowels involved have a common factor: they all

contain |A| in their internal structure.

(32) Short vowels alternating with schwa (Backley 2011)

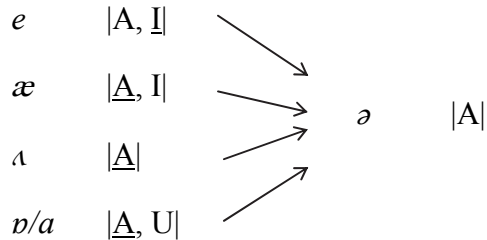

In this system, I assume that the long vowels and diphthongs, such as *ɜ:*, *aɪ* and *əʊ* (*oʊ*), which alternate with schwa also have |A| in their representation.

By contrast, as shown in (28) and (30), the vowels *i:* and *u:*, which never alternate with schwa, have no |A| element: rather, *i:* is represented by |I| and *u:* by |U|.

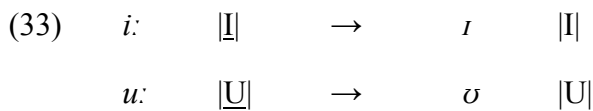

Backley (2011) proposes that schwa is lexically represented as |A|, assuming that vowel reduction involves a partial suppression of phonological/structural information. In other words, reduced vowels lose some of their elements as a result of the process. He claims that the reduction of *e* to *ə* is analysed as |A, I| > |A|, the loss of the element |I|. Following Backley (2011), I suppose that schwa has |A| in its representation and vowel reduction is the process of partial suppression of melodic content.

In traditional feature terms, vowel reduction is treated merely as an alternation between a full vowel and a different (reduced) vowel *ə*. But in fact, a certain structural relation exists between the two vowels in a full-reduced pair. This suggests that we can

predict what the reduced reflex of a full vowel might be: the element which represents a reduced vowel must also have been present in the representation of the original full vowel to which it is related – a vowel never reduces to another that has an entirely different element composition from its full counterpart. For instance, *v/a* (\underline{A} , U) regularly reduces to ə, not to ɪ, because *v/a* has no |I| in its representation. The vowel *i:* (\underline{I}) never alternates with ə since *i:* and ə have no element in common. Then it is clear that vowel alternation with ə is controlled by melodic composition.

In the context of a different representation system, such as one employing bivalent features, for example, the same kind of relation between full and reduced vowels may not necessarily hold. In Distinctive Feature Theory (Chomsky and Halle 1968), vowel reduction may involve no more than a switch from a plus to a minus value (or vice versa), as illustrated in (34). Irrelevant features such as [stress] and [tense] are omitted.

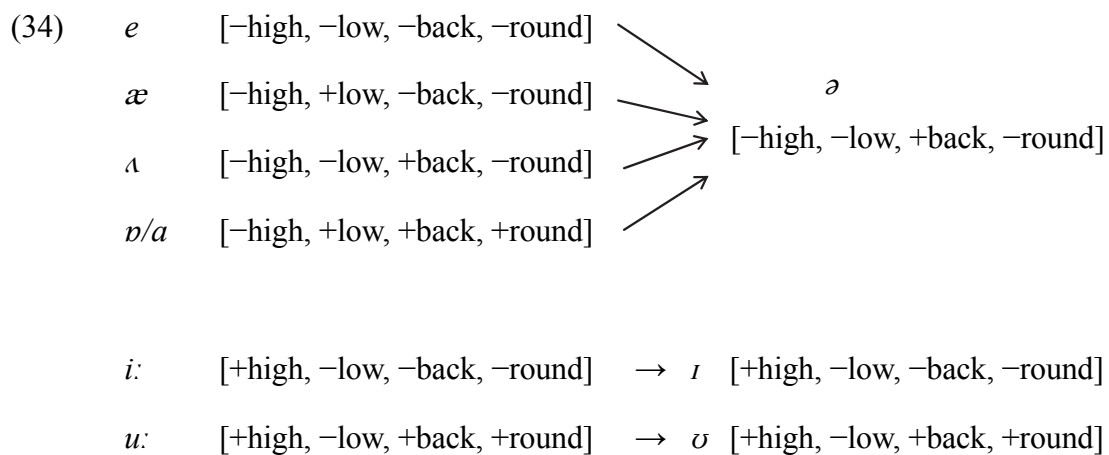

For instance, the reduction from *æ* to ə requires the switching of two values, from [+low] to [-low] and from [-back] to [+back]. Meanwhile, the reduction from *ʌ* to ə involves no switching of values at all. We can say that the feature which is common to those vowels which reduce to schwa is [-high]. However, we cannot explain why the features such as

[+low], [-back] and [+round] become [-low], [+back] and [-round] – it appears as though they are unrelated (Bacley 2011: 53). Furthermore, it is also uncertain why only [-high] remains intact and apparently prompts the vowel in question to alternate with schwa.

The same argument can be extended to theories which represent schwa as an empty structure. In this case, it must be assumed that vowel reduction involves the total suppression of elements to leave an unspecified vowel position.

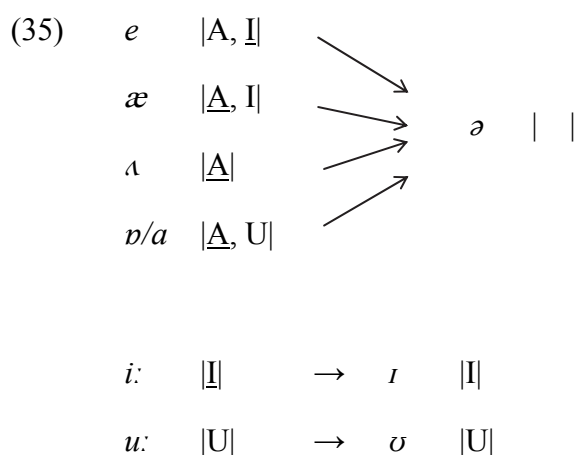

The reduced vowel ə in (35) has no element content, so we cannot establish any correlation between the full vowels and their reduced counterpart. In addition, the theory fails to explain the fact that the vowels *i:* and *u:* can preserve their melodic content; in other words, they are not subject to total suppression of elements. Therefore, an approach which regards schwa as a melodically empty vowel cannot account for the observed patterns of vowel reduction.

In this subsection, we have seen how the reduced reflex of a vowel may be predicted from the segmental representation of its full-vowel equivalent. As we discussed in (32) and (33), the vowels alternating with schwa all include |A| in their representation

whereas those vowels which alternate with other weak vowels (e.g., *ɪ*) contain no |A|. The following subsection will return to the issue of word-final schwa.

3.4.2. Word-final schwa

I will now reanalyse the contrast between 'dine' and 'Dinah', focusing on the difference between final schwa and zero (silence). In chapter 2 we considered the motivation for assuming that schwa should be represented as an empty nucleus. For the sake of convenience, the representations of *dan* 'dine' and *danə* 'Dinah' are repeated here.

(36) a. *dan* 'dine' (= (40) in chapter 2)

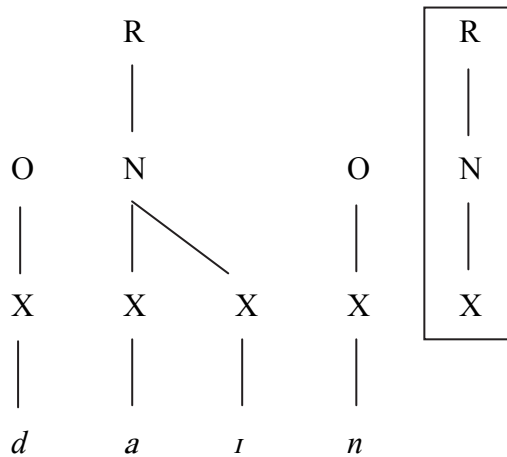

b. *damə* ‘Dinah’ (= (41) in chapter 2)

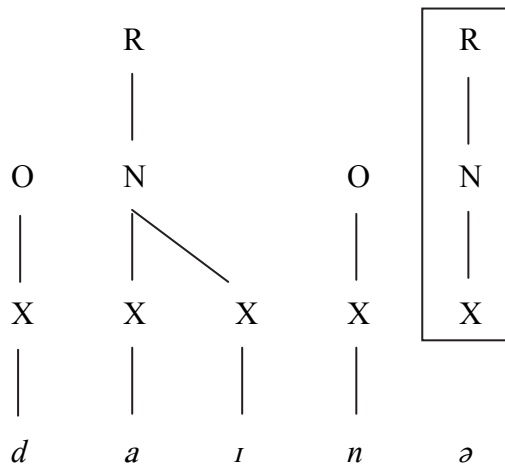

In Element Theory, the phonetic interpretation of word-final schwa is generally controlled by the Phonological Empty Category Principle (as shown in (9) in chapter 2). However, the phonetic difference between (36a) and (36b) cannot be captured by this principle: the word-final empty nucleus in (36a) is phonetically silent while the word-final empty nucleus in (36b) is phonetically realised as ə. However, we can easily capture the difference between *dam* and *damə* by assuming a representation with |A| for schwa. Note how this approach compares (favourably) with the approach described in Harris (1994), in which two types of floating |@| are proposed in order to account for differences in the realisation of word-final empty nuclei (as illustrated in (42) in chapter 2),

(37) a. *dam* 'dine'

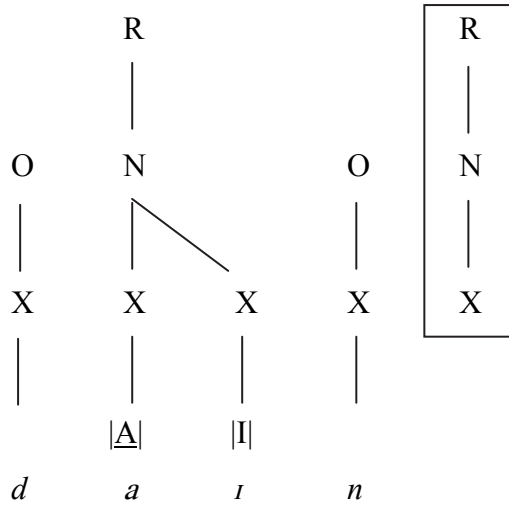

b. *damə* 'Dinah'

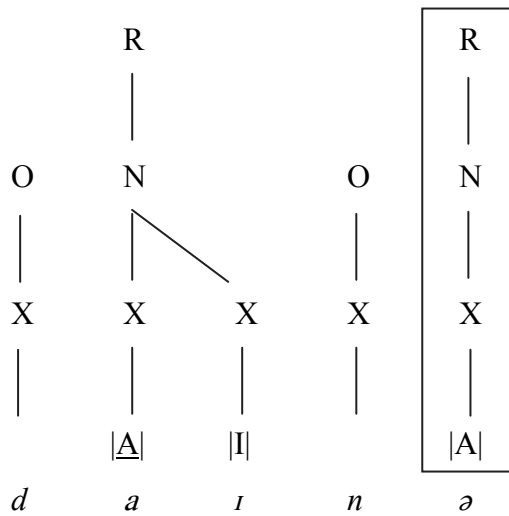

As for (37a), the word-final empty nucleus is phonetically silent because it contains no elements. The Domain-final-empty nucleus Parameter (as shown in (11) in chapter 2) also contributes to the phonetic interpretation of the word-final empty nucleus. In English, the ON setting of the parameter requires the final empty nucleus to be phonetically silent. By contrast, *ə* in (37b) is the phonetic manifestation of a word-final nucleus containing

|A| in its structure.

Without needing to include the additional object @ in the representation, we succeed in expressing a structural difference between the word-final vowels of *dan* ‘dine’ and *danə* ‘Dinah’.

3.4.3. Word-internal schwa

This section focuses on word-internal schwa. I begin by considering schwa and its ability to contrast with another weak vowel *i*, assuming ə to be the phonetic manifestation of |A| and *i* the phonetic interpretation of an empty nucleus (Backley 2011). I then examine another instantiation of schwa – a word-internal schwa which is observed in vowel (schwa) deletion. I will argue that this may be considered a case of element suppression.

In my earlier discussion of the contrast between ə and an empty nucleus (silence), I argued that the |A| vs. | | distinction can account for the contrast between schwa and another weak vowel, *i*. In non-rhotic accents we have contrasts such as that between *bædʒəz* ‘badgers’ and *bædʒiz* ‘badges’, which Backley (2011) claims can be captured by assuming that *i* is the realisation of an empty nucleus in word-medial position. This is depicted as in (38) (Backley 2011: 52).

(38) a. $bædʒə + -z \rightarrow bædʒəz$ 'badgers'

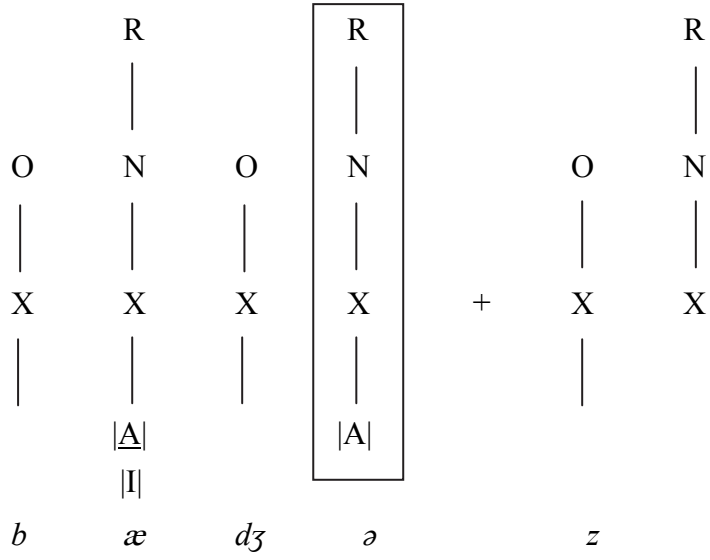

↓

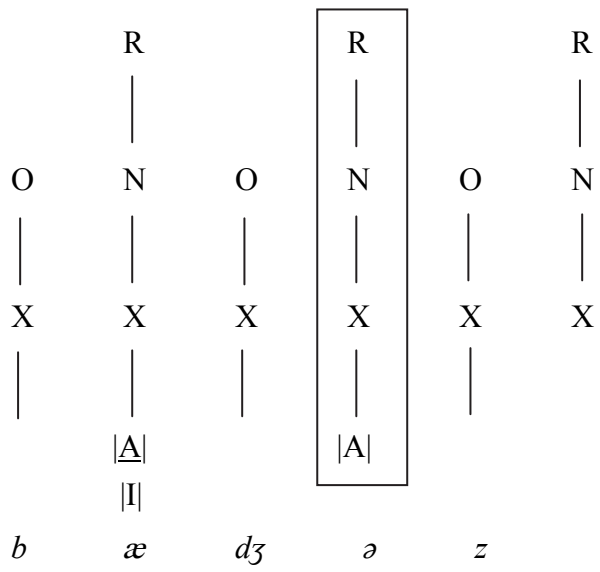

b. $bædʒ + -z \rightarrow bædʒiz$ ‘badges’

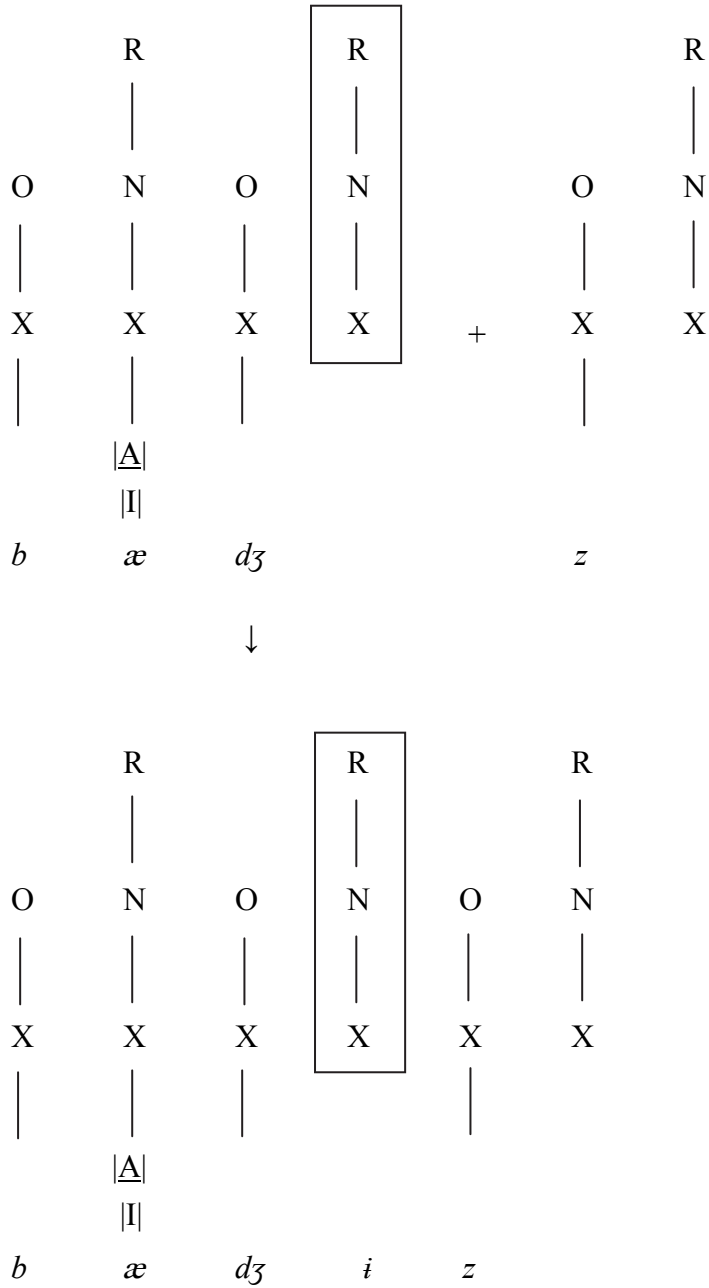

In (38a) the word-final schwa in the singular form of ‘badger’ has $|A|$ in its structure, which is lexically specified. It is retained phonetically when it becomes a word-internal schwa in the plural form. In (38b), on the other hand, the word-final empty nucleus in the

singular form of ‘badge’ is phonetically suppressed due to the effect of the Domain-final-empty-nucleus Parameter (as shown in (11) in chapter 2). However, it phonetically manifests itself as *i* in the plural form. The *i* intervenes between two sibilants *dʒ* and *z* to make them perceivable or distinguishable. In such a manner, we can make a structural distinction between *ə* and *i* in word-internal position: the former has |A| while the latter has no element (an empty nucleus).

Now let us turn to another instantiation of schwa. Word-internal schwa tends to be syncopated in words such as *təma:təʊ* → *tma:təʊ* ‘tomato’, *fæməli* → *fæmli* ‘family’, *kæməɾə* → *kæmrə* ‘camera’, *defənət* → *defnət* ‘definite’ and *litl* → *litl̩* ‘little’, as illustrated in (39).

(39) a. *tma:təʊ* ‘tomato’

b. *fæmli* ‘family’

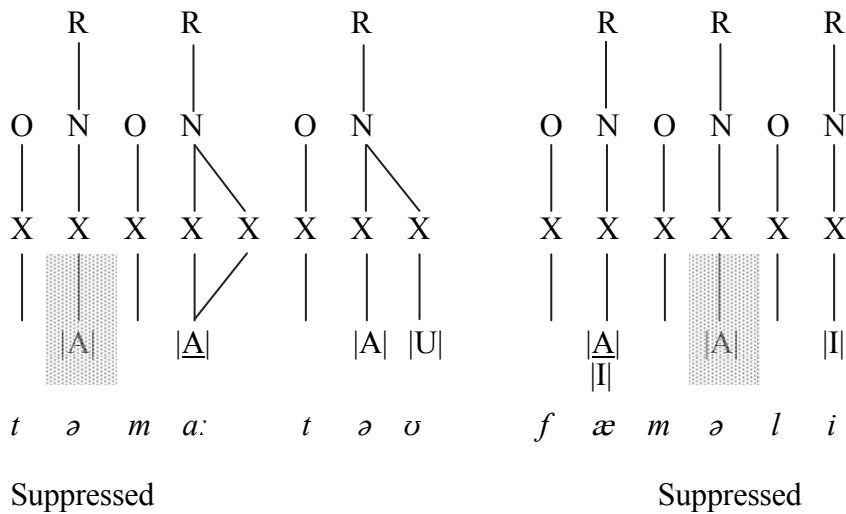

c. *kæmrə* ‘camera’

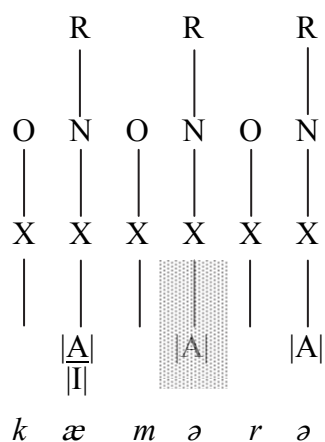

Suppressed

d. *defnət* ‘definite’¹⁴

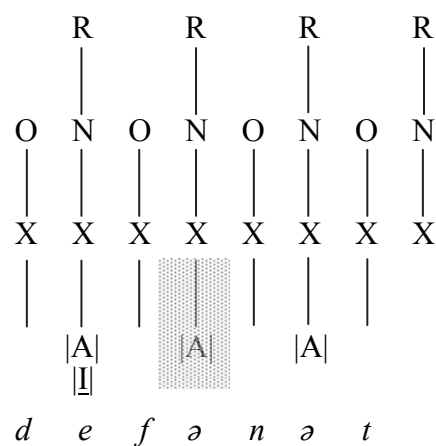

Suppressed

e. *lɪt* ‘little’

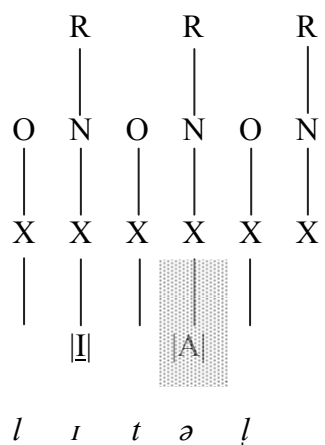

Suppressed

¹⁴ The schwa in the third syllable of (39d) is retained on account of its prosodic strength: in this configuration the first nucleus is the strongest – the ultimate head of the domain; and as such it licenses the third nucleus. The position directly licensed by the ultimate head is phonologically stronger than the position which is only indirectly licensed by the ultimate head (in this case, the second nucleus). Phonologically strong positions can support their melodic material whereas weak positions cannot.

Supposing that the syncope schwa is lexically specified as |A|, we may now regard the syncope of schwa as a case of vowel deletion: in Element Theory, it is the total suppression of elements in a weak position. In (39), the schwas in the first or second syllable are the target of syncope, and its melodic content |A| is suppressed due to the prosodic weakness of the positions where it appears, resulting in vowel deletion.¹⁵

Syncope does not always take place in (39), and when it fails to apply, |A| is phonetically realised as schwa. It is important to note here that whether or not syncope takes place is something which is parametrically determined in a given language/dialect – or more precisely, in a given grammar. If a grammar has a lexically specified |A| in the syncope site in the above cases, |A| consistently manifests itself as schwa. But if a given system has no element in the syncope site, the empty nucleus will be phonetically uninterpreted.

The same consequence is observed from the effect of the Empty Category Principle, in particular, the Domain-final-empty-nucleus Parameter and Proper Government (as given in section 2.3.2 in chapter 2). However, the process appears complicated. First of all, a necessary condition for schwa syncope is that Proper Government be parametrically invoked on this occasion. If not, Proper Government forces the empty nucleus to phonetically manifest itself as schwa. Taking this requirement for granted, the empty nucleus is properly licensed by the following nucleus, so that it is phonetically uninterpreted (i.e., silent). But in a system where an empty nucleus in the position of syncope *does* manifest itself as schwa, the parameter setting of

¹⁵ As mentioned in footnote 13, the phonological strength of each nucleus in the words of (39) is determined by prosodic licensing: the ultimate head of the domain is the stressed nucleus in each word: *təmə:təv*, *fæməli*, *kæməərə*, *defənət* and *lɪtəl*. The nucleus at the syncope site is phonologically weak because it is indirectly licensed by the ultimate head.

Proper Government must be OFF: in other words, the empty nucleus must *not* be properly licensed (properly governed) by the following nucleus in order to phonetically manifest itself as schwa.

Comparing the two accounts of vowel-zero alternation, the structural distinction expressed as |A| vs. | | and Proper Government, the former appears to be more straightforward. It is obvious that the syncope site is phonologically weak in terms of dependency relations between prosodic constituents. According to Backley (2011: 51), phonologically weak positions prefer weak expressions, which are represented either as a non-headed single element or as an empty structure, as illustrated in (10). Some systems allow a phonologically weak nuclear position to contain |A| in its structure, whereas others do not allow the position to hold any element structure at all. Thus, both systems are compatible with the requirements of phonological weakness.

3.5. Summary

This chapter has considered what kind of representation system can appropriately represent the nature of schwa, which varies phonetically and is regarded as the most common vowel in English and other languages too. It typically appears as the reduced reflex of a full vowel in contexts where vowel reduction in English is expected.

Unlike Distinctive Feature Theory, Element Theory employs privative (monovalent) units to represent segmental structure; in the case of vowels, those basic (primitive) units are |A|, |I| and |U| (Harris 1994, Backley 2011). In this framework, the presence or absence of a prime defines a binary opposition for the purposes of lexical contrast. With respect to the melodic composition of ə, Harris (1994) represents this segment without

referring to any melodic primitive. However, in this chapter we have argued that although a vocalic expression containing no elements may be convenient for describing the commonest neutral vowel, further empirical evidence is needed to support this representation because an identical word-final empty nucleus can be phonetically interpreted in two different ways, e.g., the word-final empty nucleus in *dann* ‘dine’ is silent whereas the word-final empty nucleus in *dannə* ‘Dinah’ is pronounced as schwa. Without introducing any additional devices, Harris’ analysis cannot account for the dual phonetic interpretation of this kind of word-final empty nucleus.

In this chapter I have offered an alternative representation of ə by arguing that it is the phonetic manifestation of a sole mAss element |A|. Using this representation I have analysed a number of phonological phenomena involving ə, one of them being vowel reduction – the interaction between a full vowel and a reduced vowel. Assuming the representation of ə as the element |A|, this chapter has also argued that the pattern is predictable from the element composition of full (unreduced) vowels.

4 Representing nuclear expressions in Precedence-free Phonology

4.1. Introduction

In the pursuit of a strictly monostratal model of phonology, morpheme-internal phonological properties are fully specified in lexical representation (Nasukawa 2011, 2014, 2015ab). Given this, information relevant to precedence relations between phonological units is redundant in representations. Dependency relations holding between phonological units are sufficient to analyse recurrent phenomena. The representational model which most clearly illustrates this approach is Precedence-free Phonology developed by Nasukawa (2011, 2012, 2014, 2015ab), in which phonology functions not only as an interpretive device, but also as a computational module which concatenates phonological primitives to determine the phonological shape of morphemes. In this model, precedence is not a formal property; rather it is regarded as a by-product of phonetic realisation performed by the articulatory-perceptual (AP) systems.

This chapter considers how we can formally represent vowel systems, especially that of English, in the context of Precedence-free Phonology. The structure of this chapter is as follows. Section 4.2 argues how the two relational properties of precedence and dependency have been handled by different theoretical approaches. Then section 4.3 introduces the basic concepts in Precedence-free Phonology. In section 4.4 I motivate the representation of English vowels: to validate the discussion in section 4.3, different types of vowel reduction in English will be analysed in 4.4 by referring to the proposed

representations. Section 4.5 focuses on vowel reduction in the other languages and how it can be accounted for in the context of Precedence-free Phonology.

4.2. Relational properties in phonology: precedence and dependency

Phonology employs two relational properties: precedence and dependency. Although individual theoretical positions do vary, there is general agreement that precedence holds between segments — or, more precisely, between structural positions. These have been variously described as timing units, CV units, and skeletal (X) positions (Nasukawa 2011: 280-286; cf. Lowenstamm 1981, Clements and Keyser 1983, Anderson and Ewen 1987, McCarthy 1988, Kaye 1989, Hayes 1990, Harris 1994, Brockhaus 1995, Clements and Hume 1995, Nasukawa and Backley 2005a).

(1) Precedence relations at the prosody-melody interface (Nasukawa 2011: 281)

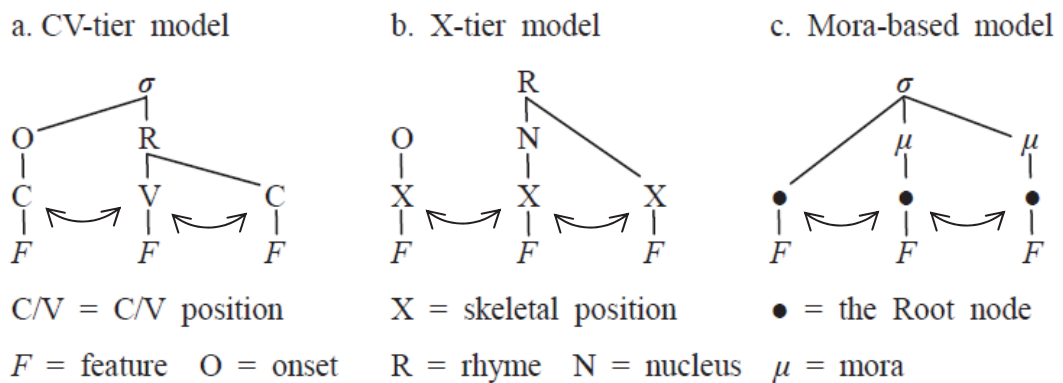

But in addition, the notion of precedence has also been applied to the description of consonantal contour segments such as affricates and prenasalised obstruents, where linear ordering relations are assumed to hold between units smaller than a segment — for

example, units such as [\pm continuant] and [\pm nasal] (Sagey 1986, Nasukawa and Backley 2008). What this indicates is that precedence plays a central role in relations between segments at the skeletal level and also within individual segments. On the other hand, it appears to have no bearing on another important domain within phonology, that of syllabic/prosodic structure.

(2) Precedence relations between primitives (features)

Affricates (e.g., *tʃ*, *dʒ*)

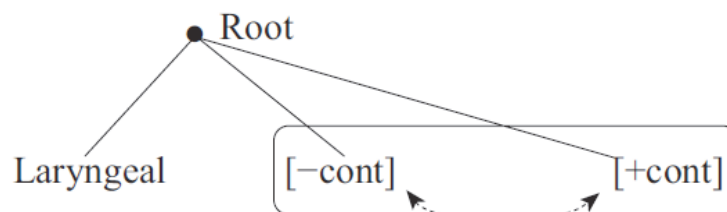

The other relational property, dependency is an asymmetric relation between phonological units and it may be also found in any of the following guises: government (Kaye, Lowenstamm and Vergnaud 1990), licensing (Ito 1986, Goldsmith 1990, Harris 1994), strong vs. weak (Lieberman and Prince 1977) and others. Dependency is typically encoded in the following contexts:

- (3) a. between prosodic/syllabic constituents (onsets, nuclei and rhymes) and also
- b. between phonological primitives (e.g. features, elements, particles, gestures).

(3a) is illustrated in (4).

(4) Dependency relations between prosodic/syllabic constituents

brændi 'brandy' in English

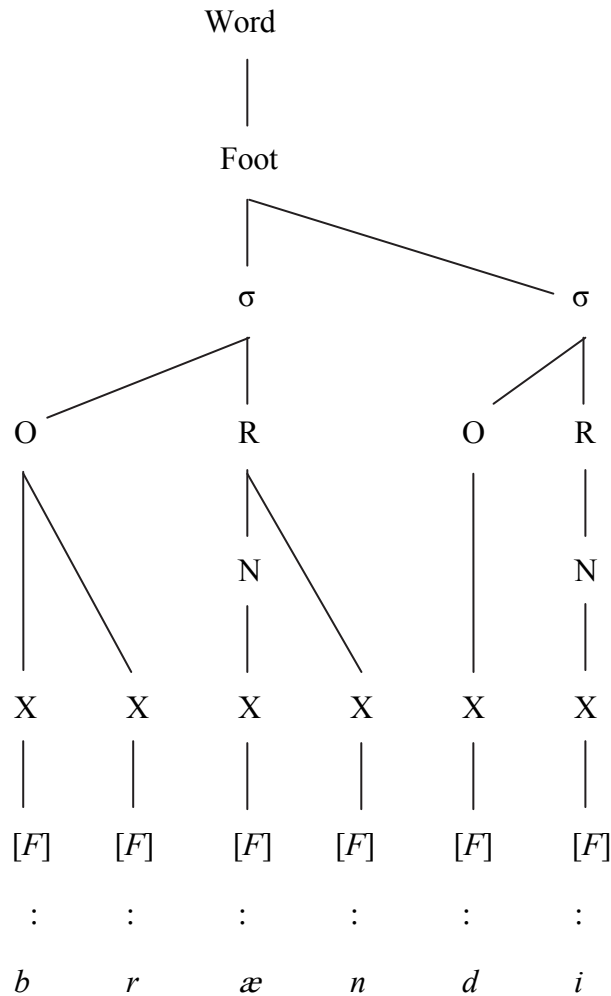

Prosody (syllable/suprasegmental structure) consists of a hierarchy of domains, in which timing units (positions) form syllable constituents (such as onsets, nuclei, rhymes), feet and prosodic words. This aspect of representation encodes relations governing phenomena such as length, weight (light versus heavy rhymes), syllabification, stress assignment, vowel syncope and agreement processes.

As for (3b), dependency also operates within segments, where internal structure is represented by means of dependency relations between phonological primitives (McCarthy 1988, Anderson and Ewen 1987, Harris 1994, Clements and Hume 1995, Nasukawa and Backley 2005ab). For example, Feature Geometry (FG) formalizes feature groupings in terms of hierarchical dependency structure (Clements 1985; Sagey 1986; McCarthy 1988; Halle 1992, 1995; Clements and Hume 1995; Halle, Vaux and Wolfe 2000).

(5) Dependency relations within a segment: Feature Geometry (McCarthy 1988)

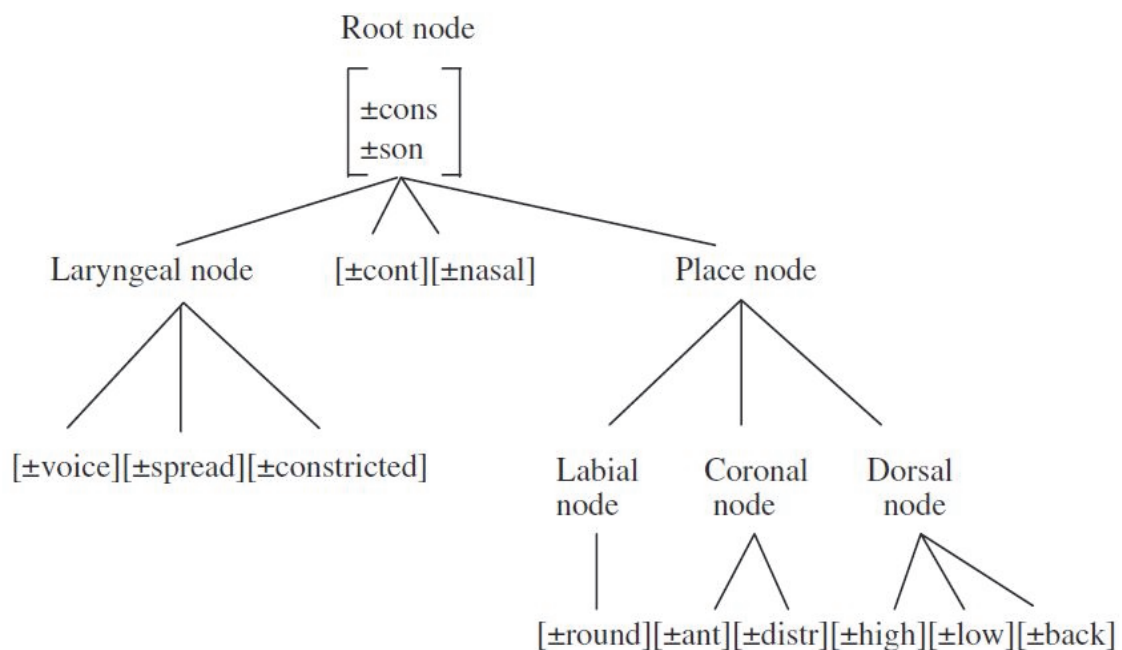

The top node in the above structure is the Root node (on which the major class features [±consonantal] and [±sonorant] are dependent), which dominates the two ‘class’ nodes Laryngeal and Place and also the features [±continuant] and [±nasal]. Furthermore, the Laryngeal node dominates the features [±voice], [±spread glottis] and [±constricted glottis] while the Place node dominates three nodes: Labial (containing [±round]), Coronal

(containing [±anterior] and [±distributed]) and Dorsal (containing [±high], [±low] and [±back]). Thus, the internal structure of a segment is represented through dominance-dependency relations between phonological units.

- (6) Dependency relations within a segment: Element-based Geometry (Harris 1994, Harris and Lindsey 1995, cf. Nasukawa and Backley 2008)

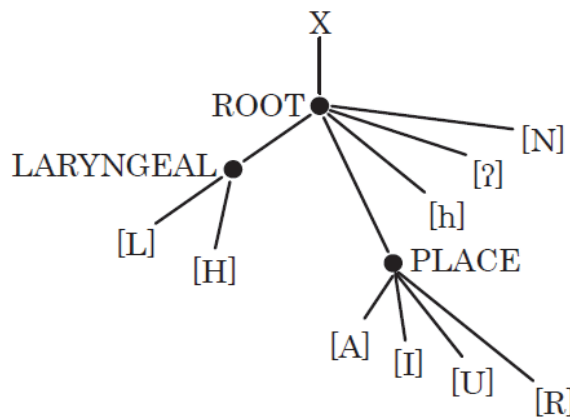

Within the context of Element Theory, Harris (1994) proposes the above segment-internal structure. In this configuration, a PLACE node dominates the resonance elements [A I U R] while a LARYNGEAL node dominates the source elements [L H]. The remaining elements [h ? N] are directly dependent on a ROOT node, which integrates the entire set of primitives in a single segment.

However, in the interests of representational minimalism (which aims to eliminate redundancy from representations), some recent theories of representation abandon one of these two relational properties — either precedence or dependency — and analyse phonological phenomena by employing only the other property. As Nasukawa (2015b: 1) discusses, two opposing views exist.

- (7) a. The strict CVCV model of Government Phonology (Scheer 2004, 2008) abandons dependency and describes phonological phenomena by referring only to precedence.
- b. Precedence-free Phonology (Nasukawa 2014, 2015ab) abandons precedence and describes phonological phenomena by referring only to dependency.

Although both views make phonological representations theoretically more restrictive, each assumes a totally distinct model of phonological representation.

Regarding (7a), Scheer (2004, 2011) claims that intra-morphemic representations contain no dependency-based prosodic structure. He assumes that syllabic structure is merely a convenient tool for describing phonological phenomena and has the function of a diacritic. Scheer (2004, 2011) therefore claims that intra-morphemic structure should be a flat structure consisting of CV sequences. According to Nasukawa (2015b), Scheer's strict CVCV model is assumed to be based on the following premises.

- (8) a. Intra-morphemic phonological structure consists of a set of linearly-ordered segments in the lexicon.
- b. Phonology is a module which merely interprets fully concatenated strings of morphemes. Phonology is not responsible for constructing phonological structure in the lexicon.

In the strict CVCV model, the premise (8a) allows the model to employ a flat structure consisting of CV units which play a core role in representations. The premise (8b) seems consistent with the reverse T model of the language faculty, where phonology is a module

that maps linguistic objects constructed by the syntax (computational system) into phonologically pronounceable objects.

Precedence-free Phonology (7b), on the other hand, employs the alternative premises in (9) (Nasukawa 2015b: 213).

- (9) a. Intra-morphemic phonological structure consists of no segment-based precedence information, but of a set of features which are hierarchically concatenated.
- b. Phonology is a module which not only interprets fully concatenated strings of morphemes, but is also responsible for lexicalization (building the phonological structure of morphemes in the lexicon).

The premise (9a) is conceived within a strictly monostratal model of phonology (Nasukawa 2011, 2012) which does not refer to any properties relating to precedence relations between segments (or between other phonological units) since precedence is regarded as being representationally redundant and merely a natural result of interpreting the dependency relations holding between phonological units in the dependency-based hierarchical structure. As for the premise (9b), then, phonology is not only an interpretive device but also a module which concatenates phonological primitives (e.g., features, elements) in order to define the phonological shape of morphemes. Lexicalisation of this kind may be viewed as a phonological operation which parallels the structure-building operation in syntax. In the Precedence-free Phonology model, precedence is regarded as nothing more than a by-product of phonetic manifestation relevant to the sensorimotor systems.

This chapter takes the view described in (7b) and (9), in which precedence relations are absent from phonological representations and morpheme-internal lexical structure is represented entirely by dependency relations between units.

4.3. Basics of Precedence-free Phonology

4.3.1. Elements as the basic building blocks of phonological structure

In phonological studies, it has been generally assumed that the units for building representations are segments, or in formal terms, CV units (alternatively X slots or Root nodes), which are not minimally contrastive units.

(10) = (8)

Dependency relations between prosodic/syllabic constituents

brændi 'brandy' in English

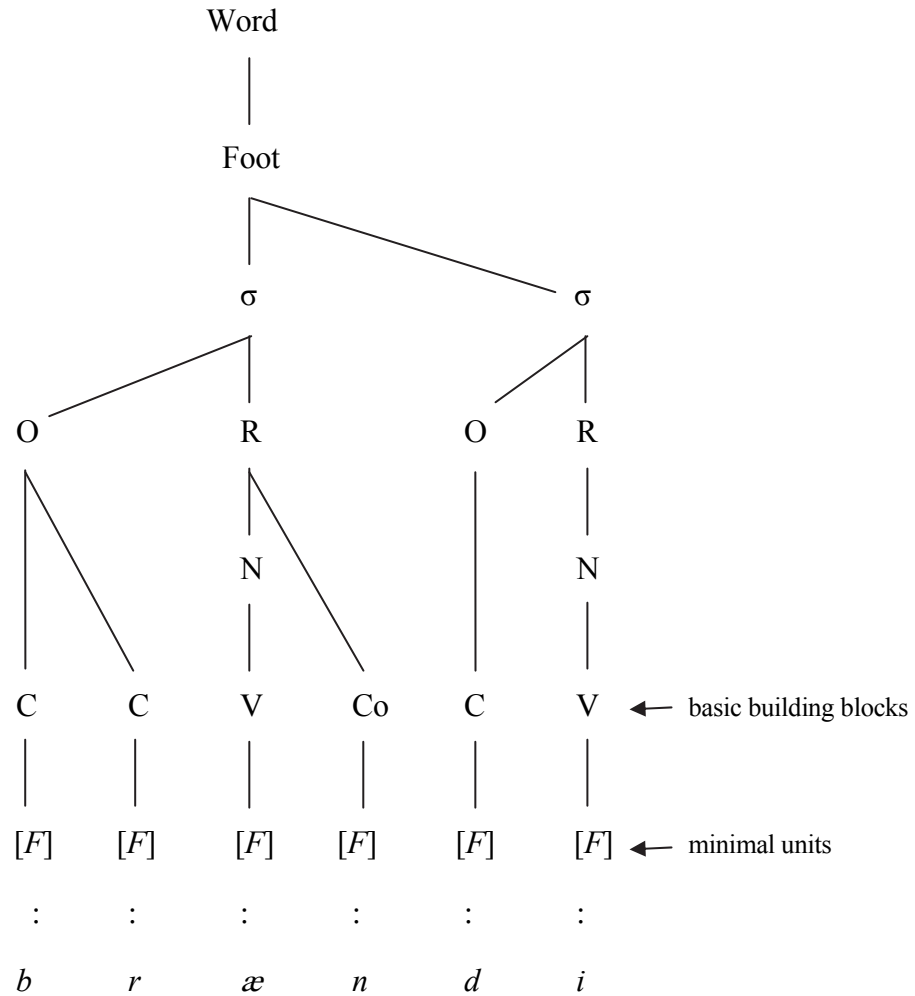

In phonology, the minimal units are usually thought to be features, not segments or CV units. This is a crucial point which makes phonological representations different from syntactic ones. In morpho-syntax, the units used for building structures are morphemes, and these exist as minimal contrastive units within their respective domain.

From the above configuration, the precedence-free approach to phonological representations developed by Nasukawa (2014, 2015ab) eliminates phonological units such as CV units, skeletal positions and Root nodes, all of which have been assumed to carry properties associated with precedence relations. Instead, phonological primitives such as features are regarded as the basic building blocks of phonological structure. This view contrasts with mainstream models of phonological representation that employ features, in which these features are regarded simply as the inherent properties of segment-sized units (e.g., CV units) and it is these segmental units that are taken to be the basic units of phonological structure.

In the Precedence-free model, on the other hand, features perform the function not only of CV units but also of prosodic constituents (such as onset and nucleus), which are projections of CV units: a feature functions as the head of an expression, and by adding another feature to this head feature a complex expression is constructed. The phonological shape of a morpheme is assumed to be formed by recursive operations of this kind. The feature model which uses primitives which are not structurally-fixed and which may concatenate freely is the version of Element Theory developed by Nasukawa (2014, 2015ab), in which each feature or *element* is single-valued (alternatively, privative or monovalent) and is able to exist without support from the other primitives. Therefore, unlike in models of Feature Geometry (FG: Sagey 1985, McCarthy 1988), elements can combine freely with one another.

In fact, in FG, and indeed in distinctive feature theory generally, features are regarded as minimal contrastive units but are not seen as the basic units for building phonological structure. Instead, the basic units of structure-building are assumed to be the minimal units of phonetic interpretation, which are segments – and segments are represented by CV units composed of features.

Like most types of features, elements are strictly phonological in nature and are thought to be mental objects that emerge through the observation of phonological phenomena. However, a crucial difference between elements and distinctive features is their reference to phonetic exponence. In theories employing distinctive features, for example, the phonetic exponence of features is concerned primarily with speech production rather than perception (e.g. [\pm high], [\pm back], [\pm anterior], all of which refer to articulation). By contrast, Element Theory (Harris and Lindsey 2000, Nasukawa and Backley 2008) rejects this production-oriented view in favour of a perception-oriented view along the lines of the work of Jakobson (Jakobson, Fant and Halle 1952, Jakobson and Halle 1956). Unlike the production-oriented approach, the perception-based approach to features successfully captures some important generalisations such as the correlation between labials and velars: they are linked in acoustic terms by a similar ‘dark’ spectral pattern (Backley and Nasukawa 2009, cf. the feature [grave] in labials and velars in Jakobson and Halle 1956). In addition, the perception-based approach is able to account for a stage on the acquisition path where infants begin to build mental representations for their native lexicon on the basis of perceiving adult inputs.

In Element Theory (Nasukawa and Backley 2008, Backley 2011), melodic structure is represented using the six single-valued elements |A I U ? H N|, which are assumed to be active in all spoken languages. They are listed below, along with their principal phonetic properties.

- (11) Typical acoustic exponents of elements (Nasukawa 2015b: 3, cf. Harris 2005, Harris and Lindsey 2000, Nasukawa and Backley 2008, Backley and Nasukawa 2009, Backley 2011)

	<i>label</i>	<i>spectral shapes</i>
A	‘mass’	mass of energy located in the center of the vowel spectrum, with troughs at top and bottom
I	‘dip’	energy distributed to the top and bottom of the vowel spectrum, with a trough in between
U	‘rump’	marked skewing of energy to the lower half of the vowel spectrum
ʔ	‘edge’	abrupt and sustained drop in overall amplitude
H	‘noise’	aperiodic energy
N	‘murmur’	broad resonance peak at lower end of the frequency range

These elements appear in both consonants and vowels. The different phonetic categories associated with each element are given in (12).

- (12) The phonetic manifestation of elements (Nasukawa 2014: 3, cf., Nasukawa and Backley 2008)

	<i>label</i>	<i>manifestation as a consonant</i>	<i>manifestation as a vowel</i>
A	‘mass’	uvular, coronal POA	non-high vowels
I	‘dip’	palatal, dental POA	front vowels
U	‘rump’	labial, velar POA	rounded vowels
ʔ	‘edge’	oral or glottal occlusion	creaky voice (laryngealised Vs)
H	‘noise’	aspiration, voicelessness	high tone
N	‘murmur’	nasality, obstruent voicing	nasality, low tone

The first three elements |A I U| may be grouped together as resonance elements because they are typically associated with vocalicness and prosodic phenomena in vowels, and because they also express the resonance (place of articulation or POA) properties of consonants. The remaining three elements |ʔ H N| refer to non-resonance properties such as occlusion, aperiodicity and laryngeal-source effects.

4.3.2. |A I U| as the head of the vowel expression

In theories which use elements to represent segment-internal structure (e.g., Government Phonology and its offshoots), head-dependency relations within the syllable are represented as an X-bar schema, which is widely employed in linguistic theories.

(13) a. X-bar schema

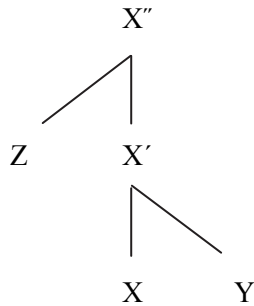

b. 'syllable' structure in GP

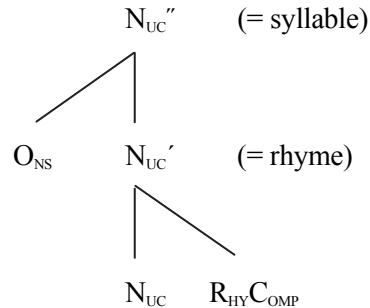

Although there are various notational differences in the way prosodic structure is represented in GP, the basic architecture of the 'syllable' may be illustrated as in (13b), where a nucleus (N_{UC}) and a rhymal complement (R_{HY}C_{OMP}) are concatenated to form the N_{UC}-labelled set (which is often referred to as N_{UC}-bar (N_{UC}[']) or 'rhyme'). Furthermore, the N_{UC}-labelled set and an onset (O_{NS}) are concatenated to form another N_{UC}-labelled set (which is often referred to as N_{UC}-double-bar (N_{UC}^{''}) or 'syllable'). In this model, then, the terminal categories serve as the basic units for constructing syllable structure.

In Precedence-free Phonology (Nasukawa 2015ab), as briefly discussed in the previous section, it is elements (minimal contrastive units) rather than syllabic constituents in (13b) which are regarded as the building blocks of phonological structure. Exploiting the schema in (13a) for representing phonological structure, we first need to investigate what kind of elements can act as the head of a domain. Since the nucleus—which phonetically manifests itself as a vowel, and as such, constitutes the obligatory part of a word—is taken to be the structural head in the model using (13b), it is natural to assume that one of the resonance elements [A I U] (which show an affinity for the syllable nucleus) should function as the head of the domain (Harris and Lindsey 1995, 2000; Nasukawa and Backley 2008: 36-40).

On this basis, one of the resonance elements must determine the quality of an empty nucleus: as an acoustically weak form, |A| is phonetically realised as \emptyset in English, |I| as *i* in Cilungu and |U| as *u* in Japanese. In this framework, then, |A|, |I| or |U| serves as the head of any nuclear expression in English, Cilungu and Japanese respectively. This allows us to explain why the central vowel is usually chosen from only three possibilities, rather than five or six. On this basis, the empty nucleus is replaced by the following three types of X-bar structure.

- (14) a. empty N_{UC} b. \emptyset c. *i* (*i*) d. *u*

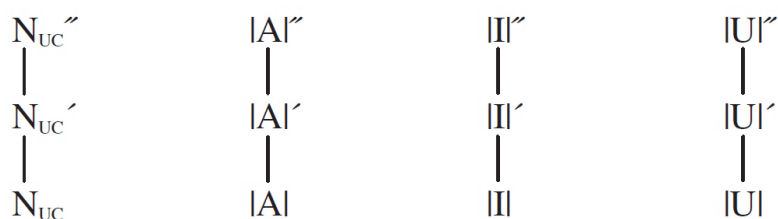

If a structural expression is formed by the single element |A|, then, it is phonetically interpreted as \emptyset , as in (14b). This is the case in English, French, Dutch and German. In Cilungu and Yoruba, an ‘empty’ nucleus (in the traditional sense) is replaced by a sole |I|. And in Japanese, it is |U| that takes the place of an empty nucleus. Accordingly, depending on the choice of head element (the foundation of the structure), languages are divided into three types in terms of the quality of the head element: |A|-type (\emptyset), in |I|-type (*i*) and |U|-type (*u*).

Taking Japanese as an example, Nasukawa (2015b) demonstrates how the five-vowel system is represented. The structure in (15a) is the representation of the Japanese vocalic baseline (a single |U|) which defines the phonetic quality of the default epenthetic vowel (*u*).

(15) Element representations of vowels in Japanese

- a. *u* b. *a* c. *i* d. *u* (*u*)

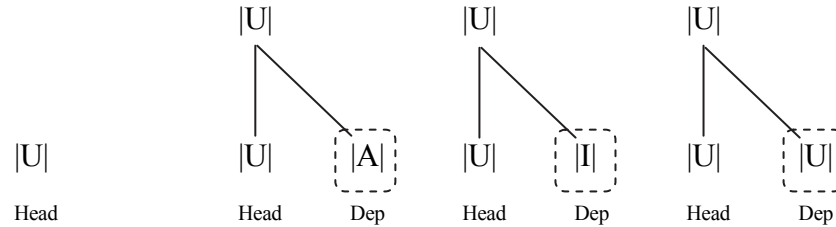

In addition, this baseline may also have a dependent element, its acoustic pattern being superimposed on to the acoustic pattern of the baseline. Accordingly, the dependents |A| in (15b), |I| in (15c) and |U| in (15d) all exhibit acoustic patterns with greater prominence than those of their baseline |U| (the head of the whole structure). Note that there is no phonetic difference between (15a) and (15d). Phonologically, however, they behave differently: the former (15a) (which is insensitive to phonological processes) is restricted to verb endings and to inter-consonantal and post-word-final consonantal positions in the nativisation of loanwords, whereas the latter (15d) appears in other contexts (cf. Nasukawa 2010c).

The above relation between structural head-dependency and phonetic prominence is attributed to an argument developed by Nasukawa and Backley (2015).

- (16) The relation between structural head-dependency and phonetic prominence
- a. Heads: important and unmarked for structure-building
but phonetically less prominent
 - b. Dependents: unimportant for structure-building
but phonetically more prominent

The same relation between structural head-dependency and phonetic prominence is found in other modules of the grammar. In syntax, for example, the default pattern of stress assignment in the verb phrase [*kissed Mary*] of [*John [kissed Mary]_{VP}*] indicates that the complement (dependent) of the verb phrase [*Mary*] is phonetically more prominent than the head [*kissed*].

(17) [*John [kissed Mary]_{VP}*]

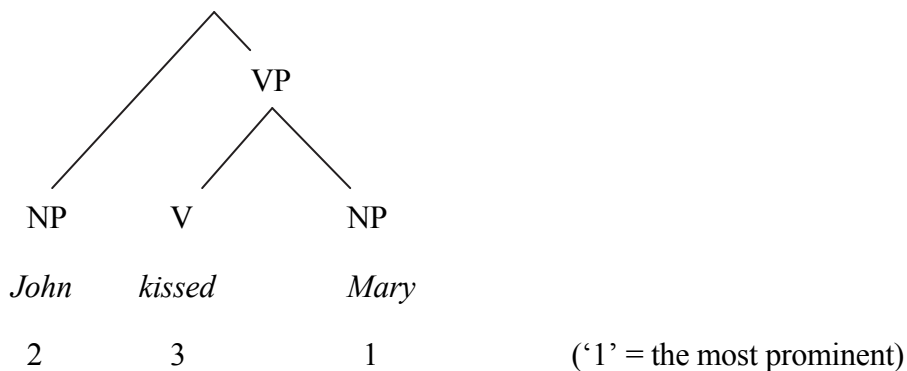

In the five-vowel system of Japanese, the remaining two vowels *e* and *o* are represented by the complex expressions |A I| and |A U| respectively. Referring to the area enclosed by the dotted line in (18a), the part of the structure in which |I| takes |A| as its dependent is phonetically interpreted as *e*. In acoustic terms, the additional (dependent) ‘mass’ pattern is added to the structurally headed ‘dip’ pattern. In this configuration, the

dependent ‘mass’ pattern is more prominent than the head ‘dip’ pattern since |A| is the most deeply embedded dependent, making it phonetically more prominent than the head (Nasukawa and Backley 2015).

(18) a. *e*

b. *o*

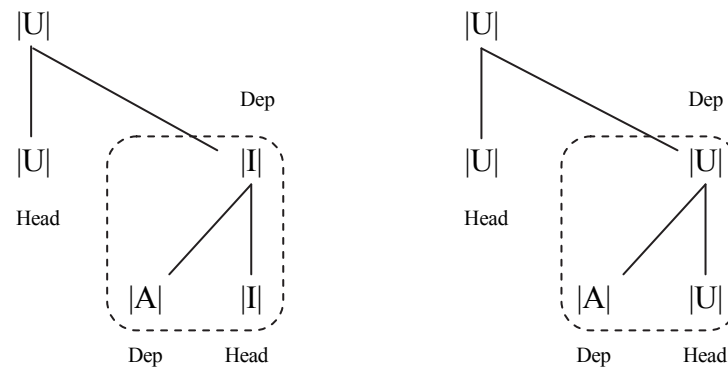

The same structural relation is found between |A| and |U| in (18b). In the |U|-headed set of |U| and |A|, the dependent |A| is acoustically more prominent than the head |U|. The validity of these vocalic structures for Japanese is discussed in Nasukawa (2014, 2015ab), where the element structures for consonantal expressions are also discussed in detail. In Nasukawa (2014, 2015ab), however, there is little discussion of the element structure of English vowels. The next section is devoted to the representations of English vowels in the precedence-free and concatenation-based approach to phonological representation.

4.4. Representing English vowels

4.4.1. Short vowels (*ə, ɪ, ʊ, ʌ, e, æ, ɒ*)

In the case of English, the head is assumed to be |A|, the structure formed by this sole head |A| being phonetically realised as *ə* (or in some dialects, as *ɨ*) as in (19a). When the head |A| takes |A|, |I| or |U| as its dependent, then the acoustic signature of the baseline |A| is masked by those elements and the overall structure phonetically manifests itself as *ə, i*, or *u* respectively.

(19) Vowel representations for English

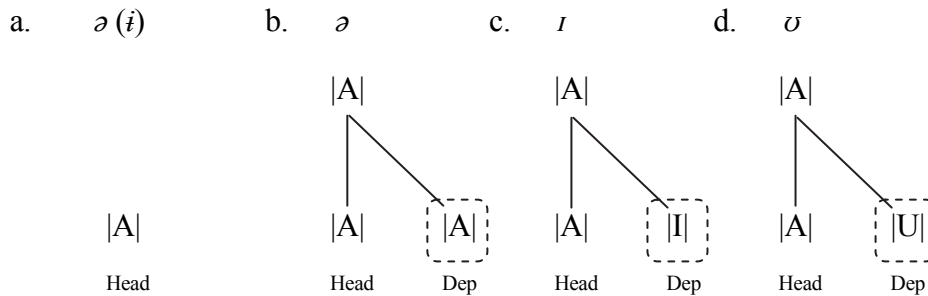

Note that like the two *us* in Japanese, there is no phonetic difference between (19a) and (19b). Phonologically, however, they behave differently: the former (19a) (which is insensitive to phonological processes) is restricted to domain-final positions and to positions which make impossible sequences legitimate in the nativisation of loanwords, while the latter (19b) appears in all other contexts.

The structures (19a) and (19b) are employed to account for the difference between *dam* ‘dine’ and *damə* ‘Dinah’ which is discussed in section 2.5. What is traditionally taken to be a silent word-final empty nucleus in the final syllable of *dam* is

replaced by the structure in (19a), which specifies only a sole baseline element |A|.

(20) *dam* ‘dine’ in English

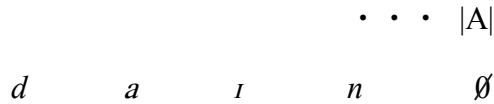

In this configuration, the single |A| is phonetically unrealised as a result of p-licensing via the ON setting of the Ultimate-head Parameter, which is a Precedence-free Phonology version of the Domain-final-empty-nucleus Parameter in section 2.3.1.

(21) The Ultimate-head Parameter (UHP)

When the ultimate head element of a given domain has no dependent in its vocalic part, the ultimate head element is p-licensed [OFF/ON]

By contrast, in the case of *damə* the (in standard GP terms) word-final empty nucleus is replaced by the structure in (19b), in which an additional dependent element |A| has been added to the baseline |A|. The |A| headed set of two |A|s is phonetically realised as ə, which must be specified in the final position of *damə*.

(22) *damə* ‘Dinah’ in English

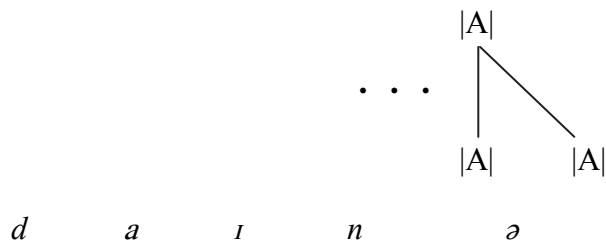

At this point, the representations of other English (RP: Received Pronunciation) vowels are considered. English has a large and relatively complex vowel system. For convenience, the RP system is given below.

(23) RP (Received Pronunciation) (Backley 2011: 43)

- | | | | | | | | |
|----|-----------------|-----------|-----------|-----------|-----------|-----------|----------------------------------|
| a. | Short vowels: | <i>ɪ</i> | <i>ʊ</i> | <i>ʌ</i> | <i>e</i> | <i>æ</i> | <i>ɒ</i> |
| b. | Long vowels: | <i>i:</i> | <i>u:</i> | <i>a:</i> | <i>ɔ:</i> | <i>ɜ:</i> | |
| c. | Diphthongs: | <i>aɪ</i> | <i>eɪ</i> | <i>ɔɪ</i> | <i>əʊ</i> | <i>ɪə</i> | <i>eə</i> <i>ʊə</i> ¹ |
| d. | Reduced vowels: | <i>ə</i> | <i>ɪ</i> | <i>ʊ</i> | | | |

First, the degree of vowel sonority is considered. In terms of element composition, vowel sonority is associated with the number of tokens of |A|: the more |A|s there are, the higher degree of sonority the vowel expression has. The |A|-headed set of two |A|s in (24b) is phonetically realised as *ə* while the |A|-headed set of three |A|s in (24c) manifests itself as *ʌ*, which has a higher degree of sonority than *ə*.

¹ A recent tendency among younger RP and Estuary English speakers is to pronounce *ʊə* as *ɔ:* (e.g., *pʊə* > *pɔ:* ‘poor’ and *fʊə* > *fɔ:* ‘sure’).

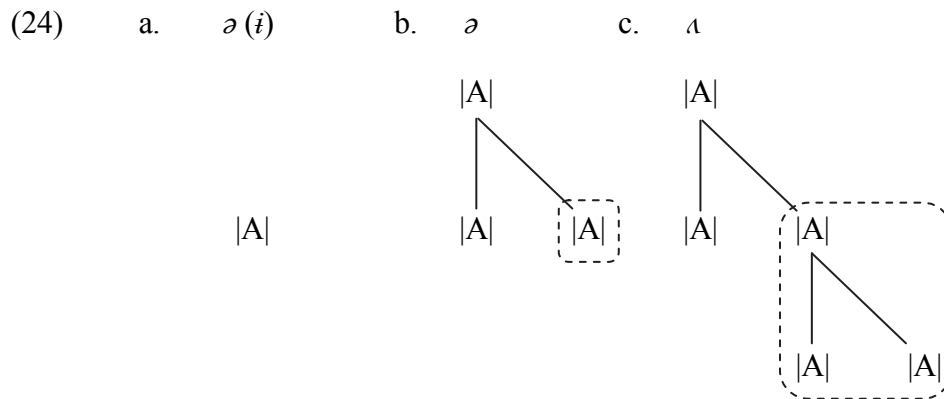

Similar representations are found in Backley (2011: 43-53) where an empty nucleus is phonetically interpreted as *i* while ə and ʌ are phonologically represented by a sole |A| in a nucleus. Following the Government Phonology tradition, the difference between ə and ʌ is attributed to the headship of |A|: it is non-headed (and phonetically recessive) in the structure for ə but headed (and phonetically more prominent) in ʌ, where headedness is represented by underlining.

(25) Backley (2011)

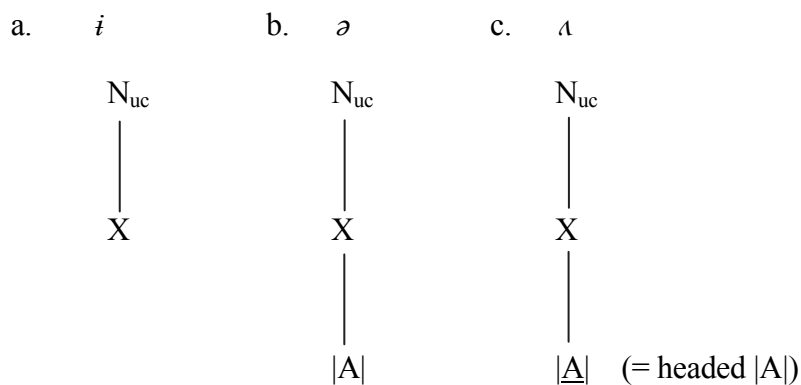

Although the structural units involved are different, Pöchtrager (2015) also makes use of similar structures, as illustrated below.

(26) Pöchtrager (2015)

- a. *i* b. *ə* c. *a(ɪ)*

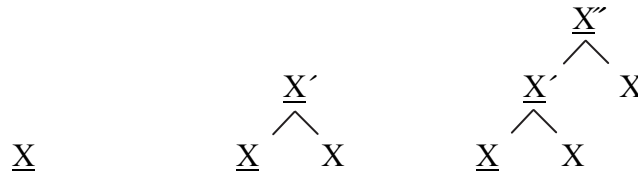

Pöchtrager claims that |A|, which displays unique phonological behavior compared with the other resonance elements |I| and |U|, is replaced by the structure in (26b), where \underline{X}' is the projection of \underline{X} which has X (a nuclear position) as the complement. The further projection of \underline{X}' is \underline{X}'' which contains X as the complement of \underline{X}' . In this configuration, vowel sonority (corresponding to vowel height) is associated with the number of Xs: the more Xs there are, the more sonorous the vowel expression is.

Returning to the segment-internal representations used in Precedence-free Phonology, we now discuss the other short monophthongs *e*, *æ*, and *ɒ* in English. The front mid short vowels *e* and *æ* are both assumed to be the realisation of the set of |A| and |I| in the complement of the baseline |A|.

- (27) a. *e* b. *æ*

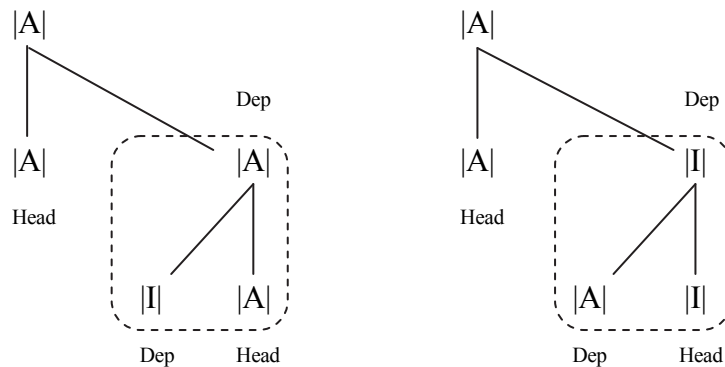

In both cases, |A| and |I| are combined asymmetrically to form a vowel expression. The structural roles of |A| and |I| for *e* are different from those for *æ*: within the domain marked out by a dotted line in (27a), |A| is the head and |I| the dependent, while the reverse dependency relation holds between |A| and |I| in the corresponding part for *æ* in (27b). In acoustic terms, the dependent ‘dip’ pattern is added to the ‘mass’ pattern in (27a). In this configuration, the dependent ‘dip’ pattern is more prominent than the head ‘mass’ pattern since |I| is the most deeply embedded dependent, making it phonetically more prominent than the head |A|. The reverse relation holds between the dependent |A| and the head |I| in the structure for *æ* in (27b).

The remaining mid short vowel *ɒ* is represented as follows.

(28) a. *ɒ*

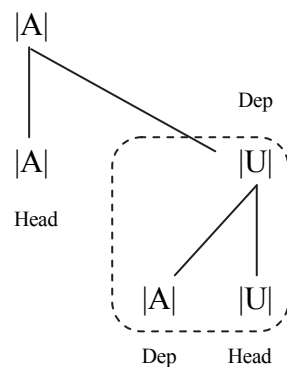

In the domain marked out with a dotted line, the |U|-headed set consisting of |U| and |A| phonetically manifests itself as *ɒ*. When the reverse dependency relation holds between |U| and |A|, the whole expression is phonetically interpreted as *o*, which is not employed in RP English.

4.4.2. Long vowels (*i:*, *u:*, *a:*, *ɔ:*, *ɜ:*)

In Precedence-free Phonology, vowel length differences correspond to differences in the number of levels to which the vocalic part (consisting of elements) attaches in the hierarchical structure. Given Backley's claim (2011) that *a:* is phonologically the long counterpart of *ʌ*, the difference between the structures for *ʌ* and *a:* is attributed to the number of levels which take *|A|* as a dependent. This is illustrated below.

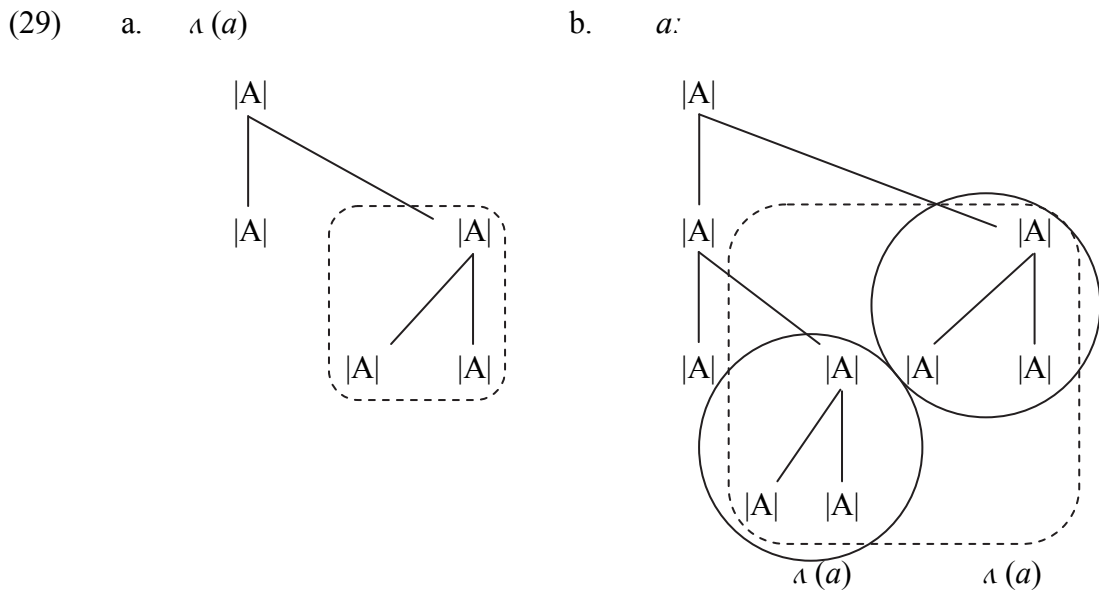

The same applies to the other long vowel structures. For example, the structure for *ɛ:* is illustrated in (29b), where the structure for *ə* (29a) appears twice: at the level of the first projection and at the level of the second projection. This configuration is phonetically realised as the long vowel *ɛ:*.

(30) a. ə

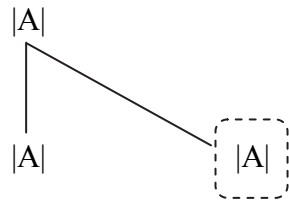

b. ε:

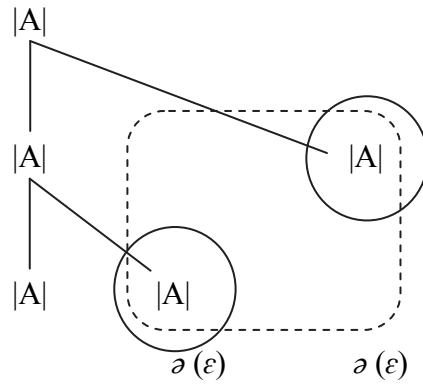

The remaining long vowels *i:*, *u:*, *ɔ:* are also represented in the same manner. In the structure for *i:* in (31b), the structure for *ɪ* (31a) can be found not only at the level of the first projection but also at the level of the second projection.

(31) a. ɪ

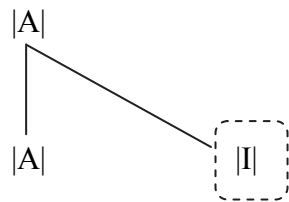

b. i:

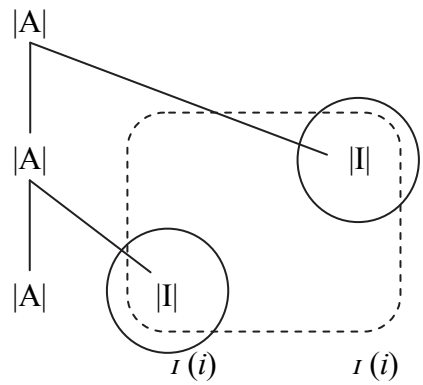

The same is true for the representations for *u:* and *ɔ:*: the structures (32b) and (33b) contain the structures (32a) and (33a) twice, respectively.

(32) a. σ

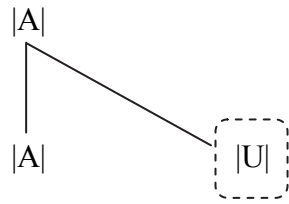

b. $u:$

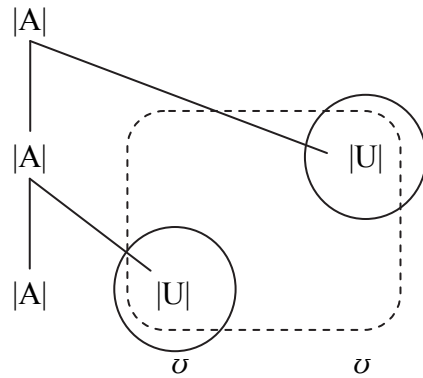

(33) a. ν

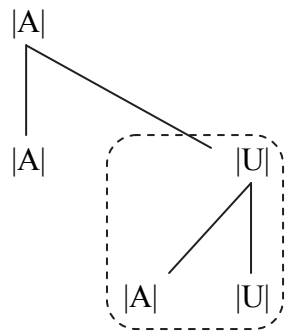

b. $\nu:$

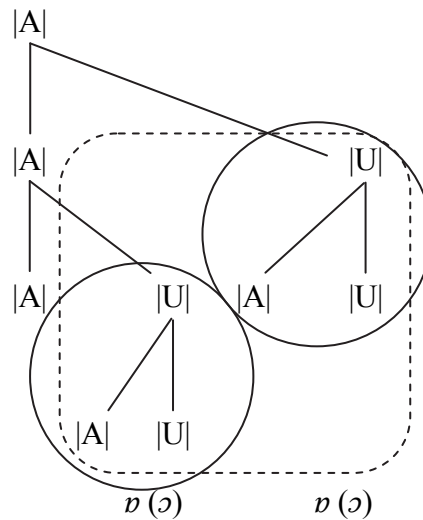

4.4.3. Diphthongs (ai , ei , $\text{ɔ}i$, aʊ , əʊ , $iə$, $eə$)

Finally, I consider how the English diphthongs (ai , ei , $\text{ɔ}i$, aʊ , əʊ , $iə$, $eə$) are represented in Precedence-free Phonology. Diphthongs are primarily classified into two groups: closing (or ascending) diphthongs (ai , ei , $\text{ɔ}i$, aʊ , əʊ) and centering diphthongs ($iə$, $eə$). Furthermore, the closing diphthongs are divided into two sub-groups: diphthongs ending in the high front vowel i and those ending in the high back vowel u (Oishi and Nasukawa 2011:

92-94).

First, we consider the high-fronting closing diphthongs. In English, the first portion of a diphthong is significantly more prominent than the second portion. For example, the first part *a* of the diphthong *ai* (as in words such as ‘ice’) is pronounced with greater duration and strength than the second part *i*. This difference between the two parts is represented structurally in (34), where the prominent part *a* is more deeply embedded while the less prominent part *i* has a higher position in the hierarchical structure.

(34) a. *ai*

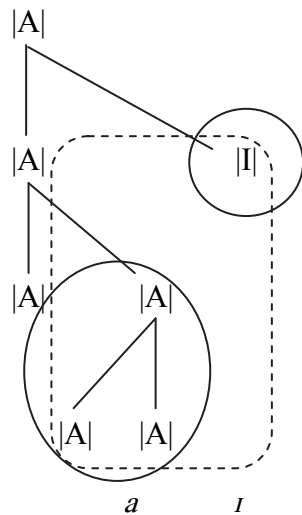

b. *ei*

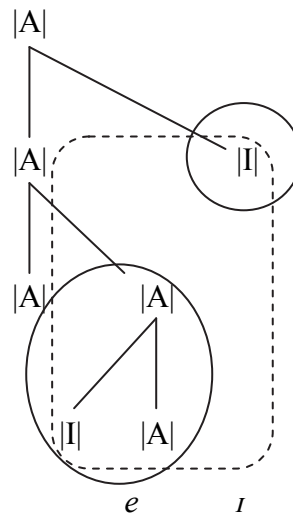

The structures for the other high-fronting closing diphthongs (*ei* (34b) and *ɔi* (35)) also embed the prominent portion (*e* (34b) and *ɔ* (35)) more deeply than the recessive portion (*i* in both (34b) and (35)).

(35) ∂I

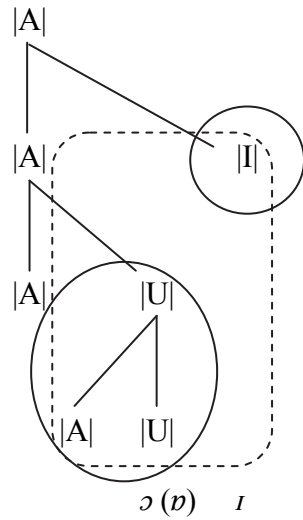

In the case of the high-backing closing diphthongs ($aɔ$, $\partial\upsilon$), the element set corresponding to the recessive portion (υ represented by a sole |U|) is dependent on the baseline element |A| at the top level, while the set for the prominent portion (a of $aɔ$ in (36a) and ∂ of $\partial\upsilon$ in (36b)) is the most deeply embedded, as illustrated below.

(36) a. $aɔ$

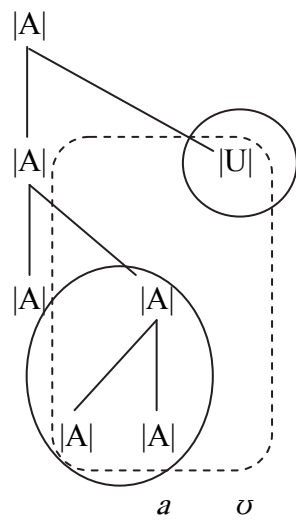

b. $\partial\upsilon$

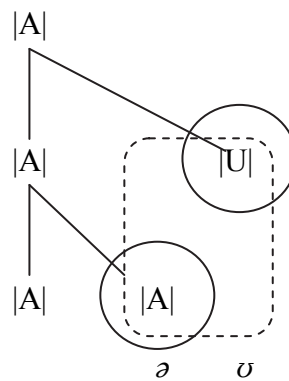

The same also applies to the centering diphthongs (*iə*, *eə*, *ʊə*), which show a transition from a peripheral vowel towards the mid central ‘weak’ vowel schwa (*ə*). Since the schwa portion in all three ((37a), (37b) and (37c)) lacks prominence, it should be the highest dependent in the structure while the more prominent parts (i.e. *i* of *iə* in (37a), *e* of *eə* in (37b) and *ʊ* of *ʊə* in (37c)) occupy the most deeply embedded position, as depicted below.

(37) a. *iə*

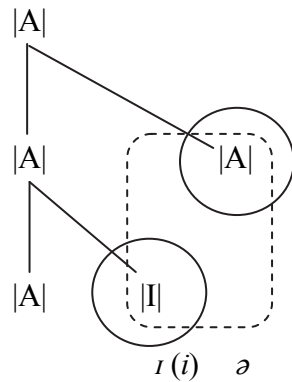

b. *eə*

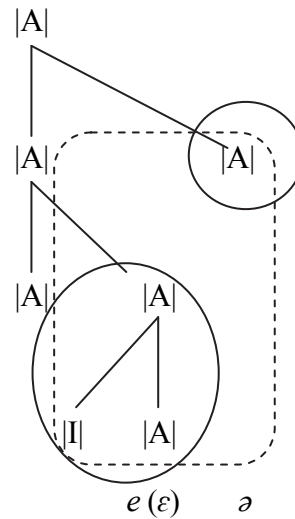

c. *ʊə*

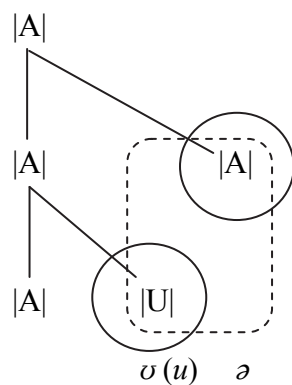

Employing the element structures for English vowels presented so far, I now analyse vowel reduction in English in the following section.

4.5. Vowel reduction in English

In English, full vowels are reinterpreted as one of the three ‘weak’ vowels ∂ ι υ in unstressed syllables (e.g., ‘*mæ*lɪs’ ‘malice’ → *m* ∂ ’lɪʃəs ‘malicious’). The vowel reduction process is illustrated in (38).

(38) Vowel reduction in English vowels I (Backley 2011: 53)

<i>Stressed (full)</i>				<i>Unstressed (reduced)</i>		
<i>Vowel</i>	<i>Example</i>			<i>Vowel</i>	<i>Example</i>	
a.	æ	mal <u>ice</u>	→	∂	mal <u>icious</u>	
b.	e	de <u>sperate</u>	→	ι	de <u>spair</u>	

First, as in (38), the mid front vowels æ and e become ∂ and ι respectively. The process may be described as follows.

(39) a. *æ* in 'mæls 'malice'

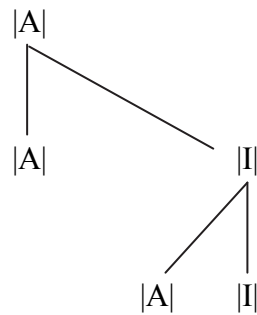

b. *e* in 'despəɾət 'desperate'

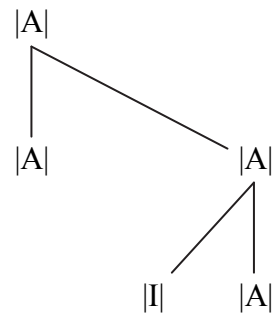

(40) a. *ə* in mæ'lifəs 'malicious'

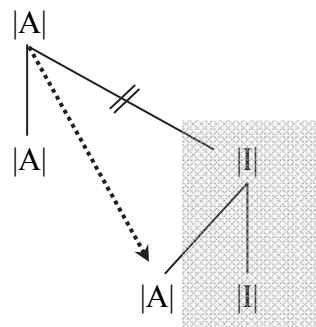

b. *ɪ* in dɪ'speɾət 'despair'

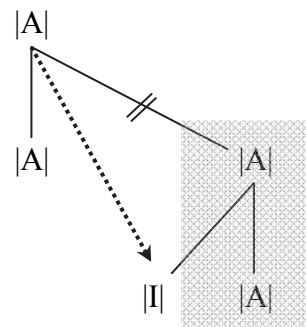

In both cases, as in (40), the most deeply embedded dependent part (|A| in (40a) and |I| in (40b)) remains intact since it is perceptually rich and contributes to contrastiveness (Nasukawa and Backley 2015). On the other hand, the other dependent parts are all suppressed. Then, the remaining most deeply embedded dependent element is directly licensed by the baseline (ultimate head) element |A|: the |A|-headed set of two |A|s is interpreted as *ə* as in (40a) while the |A|-headed set of |A| and |I| manifests itself as *ɪ* as in (40b). Further examples of vowel reduction are given in (41).

(41) Vowel reduction in English vowels II (Backley 2011: 52)

<i>Stressed (full)</i>			<i>Unstressed (reduced)</i>		
<i>Vowel</i>	<i>Example</i>		<i>Vowel</i>	<i>Example</i>	
a.	<i>i:</i>	de <u>f</u> ect (n.)	→	<i>ɪ</i>	de <u>f</u> ective
	<i>ɪ</i>	hi <u>s</u> tory	→	<i>ɪ</i>	hi <u>s</u> torical
b.	<i>u:</i>	be <u>a</u> uty	→	<i>ʊ</i>	be <u>a</u> utician
	<i>ʊ</i>	wo <u>o</u> d	→	<i>ʊ</i>	Hollywo <u>o</u> d
c.	<i>a:</i>	dra <u>m</u> a	→	<i>ə</i>	dra <u>m</u> atic
	<i>ʌ</i>	sul <u>p</u> hur	→	<i>ə</i>	sul <u>p</u> huric
d.	<i>ɒ</i>	co <u>n</u> gress	→	<i>ə</i>	co <u>n</u> gressional
	<i>ɔ:</i>	inst <u>a</u> ll	→	<i>ə</i>	inst <u>a</u> llation

As shown above, long vowels (*i:*, *u:*, *a:*) are all shortened in unstressed syllables. I assume that this type of vowel reduction may be the same as in (40) and is represented as in (42), where the most deeply embedded dependent part (i.e., the terminal part) remain intact while the other dependent part is suppressed. As a result, the derived structure is identical to the structure for *ɪ*.

- (42) a. *i:* in 'dɪ:fekt' 'defect' b. *ɪ* in dɪ'fektɪv 'defective'

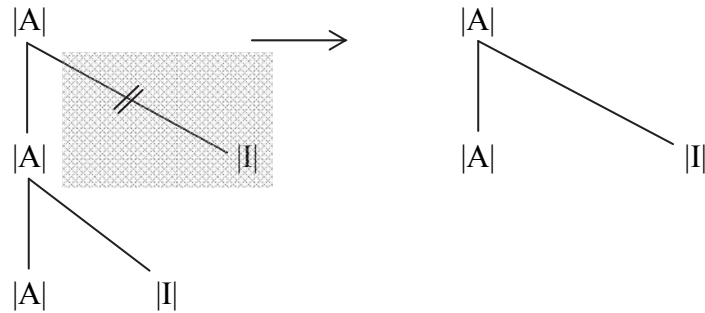

In the case of the short vowel *ɪ* in 'hɪstri' 'history', on the other hand, there is only one dependent (*I*) which is at the same time interpreted as the most deeply embedded part. Therefore no suppression takes place, as given below.

- (43) a. *ɪ* in 'hɪstri' 'history' b. *ɪ* in hɪ'stɔrɪkəl 'historical'

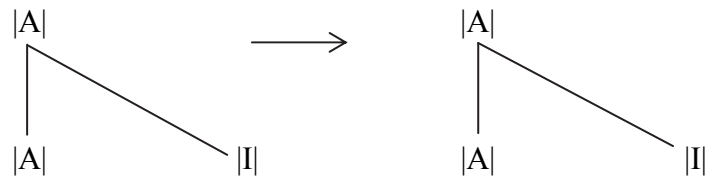

Although the reduction process has no structural impact, the unstressed *ɪ* is shortened and weakened in phonetic terms. Vowel reduction in (41b) (*u:* and *ʊ* become *ʊ*) is also explained in the same manner.

Regarding (41c) where *a:* and *ʌ* both become *ə* in unstressed syllables, only the dependent *|A|* at the most deeply embedded level remains intact. On the other hand, the other dependent *|A|*s in the configuration are suppressed. And the remaining most deeply embedded dependent element is directly licensed by the baseline (ultimate head) element *|A|*: the *|A|*-headed set of two *|A|*s is interpreted as *ə* as in both cases in (45).

(44) a. ʌ in *'sʌlfə* 'sulphur'

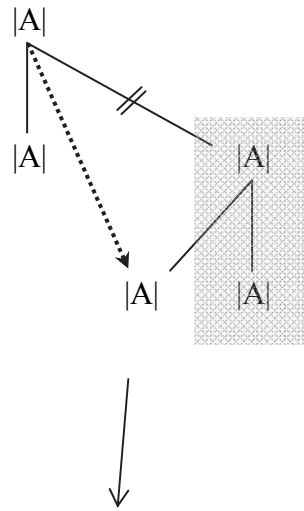

b. a: in *'dra:mə* 'drama'

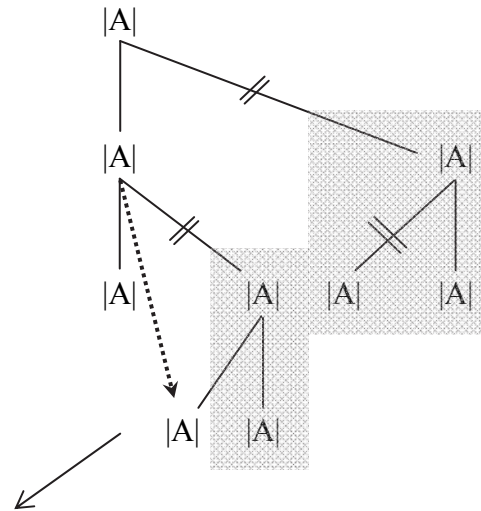

c. ə in *drə'mætɪk* 'dramatic' and *sə'l'fjuəri:k* 'sulphuric'

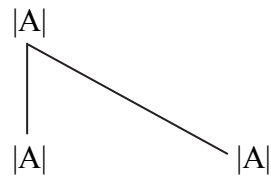

The same also applies in the process in (41d) (v and ɔ: become ə in unstressed syllables): as depicted in (45), all elements which do not reside in the most deeply embedded part of the structure are suppressed in unstressed syllables; the remaining element |A| (which is the most deeply embedded) is directly licensed by the ultimate head (baseline) element |A|.

- (45) a. *v* in 'kɒŋɡres 'congress' b. *ɔ:* in m 'stɔ:l 'install'

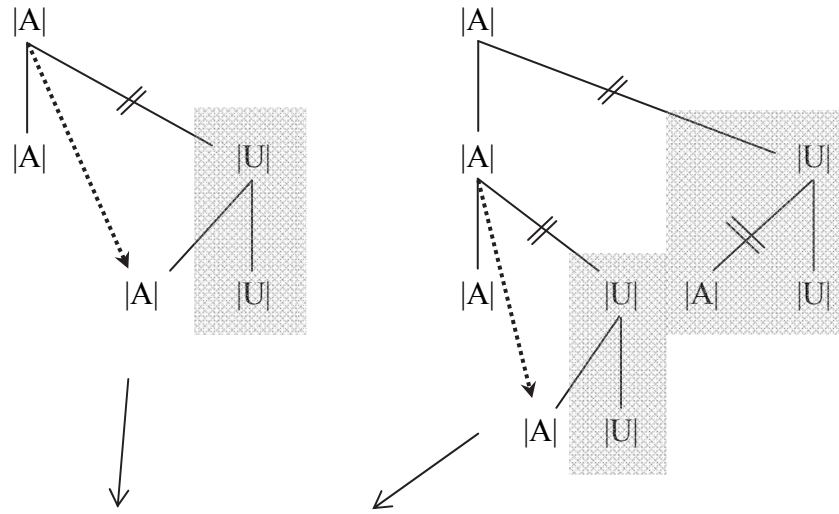

- c. *ə* in kən 'ɡrefənəl 'congressional' and ,mstə 'leɪfən 'installation'

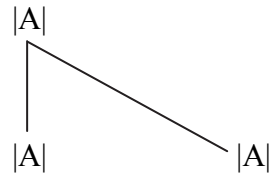

Thus in the framework of Precedence-free Phonology, vowel reduction targets elements at the intermediate levels of the hierarchical structure. On the other hand, the ultimate head and the most deeply embedded element (both of which are regarded as objects at the opposing ends) in a lexically-specified form are stable and immune to the process in question.

(46) <i>Targets of vowel reduction</i>	<i>immunity</i>
The ultimate head	✓
Most deeply embedded dependents	✓
The other dependents	✗

4.6. Vowel reduction beyond English

Following Harris (2005), vowel reduction is cross-linguistically divided into two types: centrifugal and centripetal (Harris 2005). In centrifugal reduction, vowels disperse towards the corner values *i u a*, and as a result, mid vowels are excluded either through raising or lowering (e.g., Belorussian, Luiseño). In centripetal reduction, on the other hand, peripheral vowels are centralized, though in this system not all vowels are centralized – this pattern usually co-occurs with centrifugal reduction (e.g., English, Bulgarian). Since we have discussed the latter type of reduction (centripetal vowel reduction) that is found in English, this section focuses on the former type of reduction, centrifugal vowel reduction. An example of centrifugal reduction comes from Belorussian,² as given in (47) where ‘strong’ and ‘weak’ denote stressed and unstressed vowels respectively.

² Belorussian is spoken in Belarus as an official language, along with Russian, and is also spoken in Russia, Ukraine and Poland.

(47) Belorussian

strong	i	e	a	o	u
weak	i		a		u

nóyi	“legs”	nayá	“leg”
kól	“pole (NOM)”	kalá	“pole (GEN)”
v ^l ósŋ	“spring (GEN)”	v ^l asná	“spring (NOM)”
m ^l ót	“honey (NOM)”	m ^l adóvi	“honey (ADJ)”
ǰépt	“whisper”	ǰaptáts ^l	“to whisper”
réki	“rivers”	raká	“river”
sp ^l éts ^l	“to ripen”	pasp ^l ávats ^l	“to mature”
k ^l éj	“glue”	k ^l éjónka	“oil-cloth”

In this language, unlike English, centrifugal reduction is observed, but vowel reduction takes place under the same conditions as for English (already described in the previous section): that is, vowel reduction targets elements at the intermediate levels of the hierarchical structure, as illustrated below. (To avoid having to state which element is the ultimate head (baseline), the term ‘Head’ is used for the relevant part.)

(48) Centrifugal vowel reduction in Belorussian

a. Strong

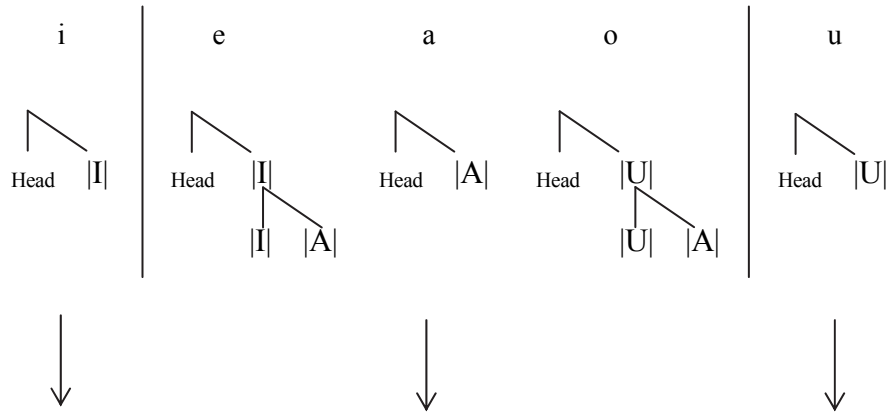

b. Weak

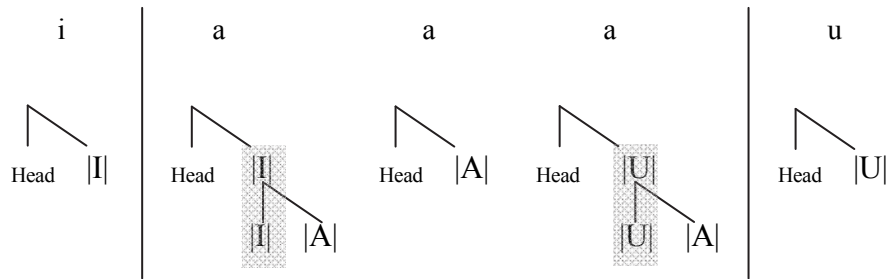

In weak contexts the vowels are dispersed towards the corners of the vowel space and interpreted as *i u a*. Here again we observe that the ultimate head and the most deeply embedded element are stable and immune to the process in question.

Another example of centrifugal reduction comes from Luiseño which is an Uto-Aztecan language of California spoken by the Luiseño people.

(49) Luiseño

strong	i e	a	o u
weak	i	a	u

cóka	“to limp”	culáʃkas	“limping”
hédin	“will open”	hidíki	“to uncover”
capómkat	“liar”	cápumkatum	“liars”
máha	“to stop”	mahámhaʃ	“slow”
kúmit	“smoke”	kumíkmiʃ	“smoke coloured”
şúkat	“deer”	páşukat	“elk”
takítkiʃ	“straight”	tákiʃ	“pottery stone”

In this language, unlike Belorussian, the mid vowels *e* and *o* become *i* and *u* respectively (rather than *a*) in unstressed syllables. This may be explained by referring to nature of the target for vowel reduction. As illustrated below, vowel reduction targets elements at the most deeply embedded level, rather than those at the intermediate levels of the hierarchical structure.

(50) Centrifugal vowel reduction in Luiseño

a. Strong

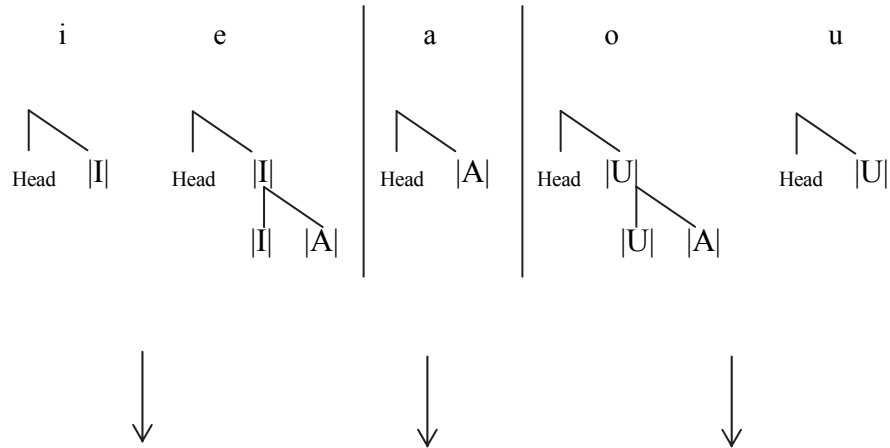

b. Weak

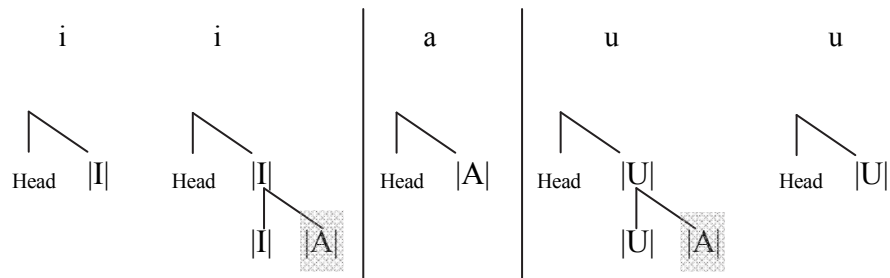

Thus there seem to be parametric choices regarding the target of vowel reduction. This may be summarised as follows.

(51)	Belorussian	Luiseño
<i>Targets of vowel reduction</i>	<i>immunity</i>	<i>immunity</i>
The ultimate head	✓	✓
Most deeply embedded dependents	✓	✗
Other dependents	✗	✓

A different setting of the above parameter brings about a different type of reduction.

4.7. Monophthongisation and diphthongisation in English

Employing the proposed representations of English vowels, this section considers two fundamental operations, which are often characterised as (i) *fusion* (composition) and (ii) *fission* (decomposition). A recurrent pattern involving (i) is vowel coalescence, which typically produces the mid vowels *e* and *o* from the sequences *a-i* and *a-u* respectively. A frequently cited example comes from a historical monophthongisation process by which the Early Modern English diphthongs *ai* and *au* developed into *ɛ:* and *ɔ:* respectively (Harris 1994: 99).

(52)	earlier	>	later English	word class
	<i>ai</i>	>	<i>ɛ:</i>	BAIT <bait, maid, day, stay>
	<i>au</i>	>	<i>ɔ:</i>	CAUGHT <caught, taut, trawl, bought, call>

The above process can be depicted as in (53a), where the vocalic set for *a* (the |A|-headed set of two |A|s) copies itself as a dependent of |I| (which is also a dependent at the highest level of the structure). Simultaneously the |I| (the dependent at the highest level) copies itself as a direct dependent of the ultimate head |A| at the first level of the |A| projection. As a result, each level has two identical |I|-headed sets of |I| plus the set for *a* (the |A|-headed set consisting of two |A|s). The whole structure is phonetically realised as *ɛ:*.

(53) a. *aɪ*



b. *ɛ:*

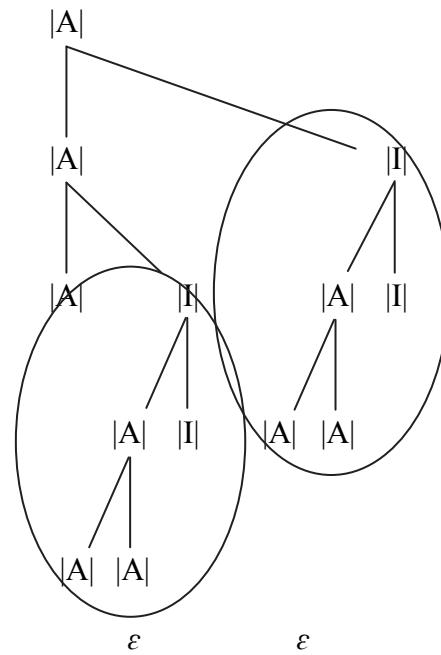
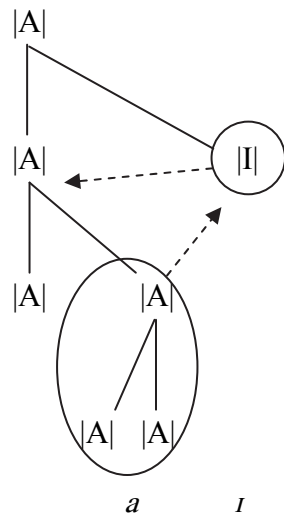

The same mechanism is observed in the historical monophthongisation by which the Early Modern English diphthong *aɪ* developed into *ɛ:*. As illustrated in (54a), the dependent $|U|$ at the top level is multiplied at the lower level as a dependent, and at the same time the $|A|$ -headed set of two $|A|$ s (which is the structure for *a*) copies itself as a dependent of $|I|$ at the higher level. As a result, the derived structure in (54b), which is phonetically interpreted as *ɛ:*, contains two identical $|U|$ -headed sets of $|U|$ plus the set for *a* (the $|A|$ -headed set comprising two $|A|$ s).³

³ In this version of Element Theory, monophthongisation has the appearance of a melodic fortition process, in the sense that structure increases in complexity. In other versions of Element Theory, it also seems that a fortition requires each X-slot to make a copy of an element, which effectively increases the number of elements in the expression.

(54) a. *aʊ*



b. *ɔ:*

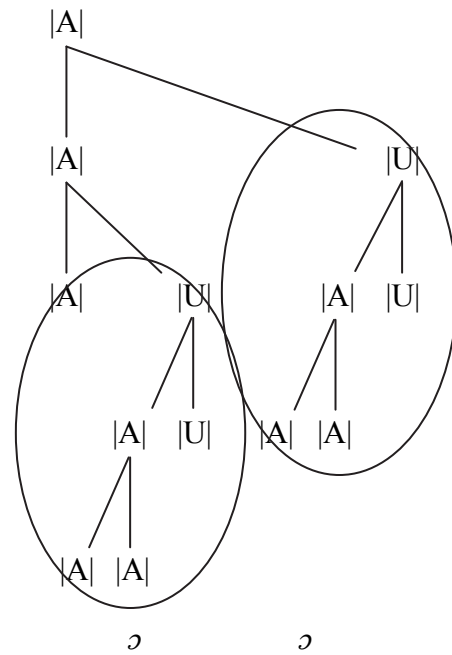
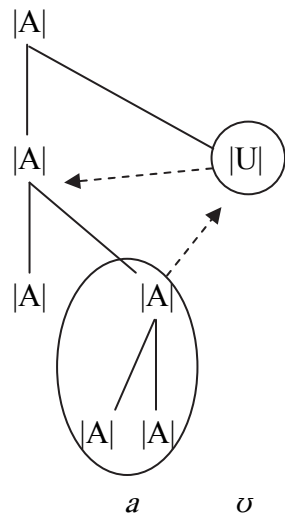

Another example of monophthongisation is observed in Estuary English, a present-day variety of English, as well as in modern forms of RP spoken by younger speakers, in which the diphthongs *eə* and *ʊə* are realised as *ɛ:* and *ɔ:* respectively.

aɪ → *ɛ:*

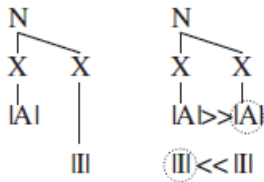

|A| in X₁ (the first part of *aɪ*) and |I| in X₂ (the second part of *aɪ*) extend to X₂ and X₁ respectively.

As a result, both positions are phonetically interpreted as *ɛ* which is the phonetic manifestation of a complex expression combining |A| and |I|.

(55)	RP		Estuary	Examples
	$\varepsilon\emptyset$	>	$\varepsilon:$	<i>tʃeə</i> ‘chair’, <i>heəri</i> ‘hairy’
	$\upsilon\emptyset$	>	$\upsilon:$	<i>pʊə</i> ‘poor’, <i>tʊə</i> ‘tour’

In the $\varepsilon\emptyset$ -to- $\varepsilon:$ alternation, as depicted in (56), the [I]-headed set of [I] and [A] for ε of $\varepsilon\emptyset$ is simply copied at the higher dependent part. The representational outcome is phonetically realised as $\varepsilon:$.

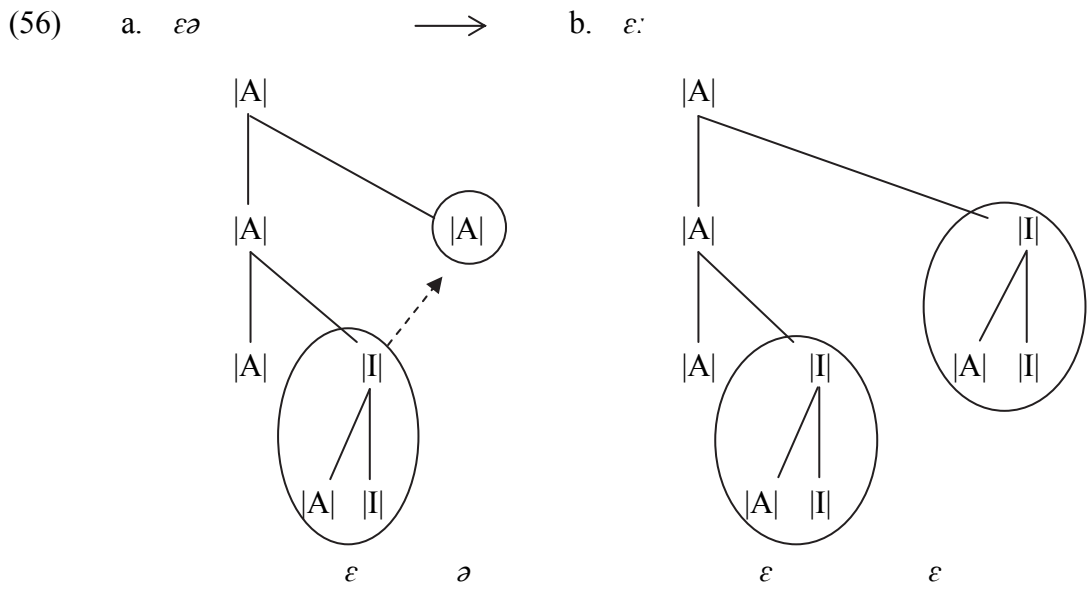

In the case of the development of $\upsilon\emptyset$ to $\upsilon:$, like (53) and (54), the structural operations in question are more complicated: [U] for υ of $\upsilon\emptyset$ copies itself as the direct dependent of the ultimate head $|A|_1$ and at the same time takes $|A|_2$ as a dependent. In addition, $|A|_2$ copies itself as the dependent of [U]. The resulting structure phonetically manifests itself as $\upsilon:$.

(57) a. $ʊə$ \longrightarrow b. $ɔ:$

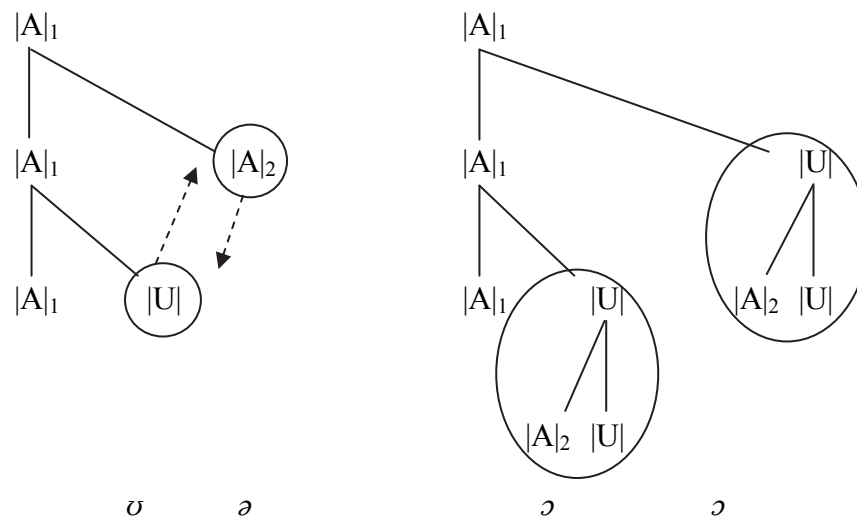

Returning back to historical changes in English, the following types of diphthongisation are observed (Harris 1994: 100).

(58)				word class		
	$e:$	$>$	$eɪ$	$>$	$aɪ$	BAIT = MATE <make, fate, same, tale>
	$o:$	$>$	$oʊ$	$>$	$əʊ$	BOAT <boat, home, go, road>

The reflexes at each stage are found in different present-day dialects. The original monophthongal reflexes ($e:$ and $o:$) are retained in some dialects spoken in Scotland, Ireland and the North and the West of England. The reflexes corresponding to the intermediate stage ($eɪ$ and $oʊ$) are the most widespread across different dialects. The reflexes at the final stage in (58) ($aɪ$ and $əʊ$) are identified in the southeast of England and in the southern hemisphere (Harris 1994: 100).

In terms of representation, the diphthongisation of the mid front vowel ($e: > eɪ$) in (58) is illustrated in (59) where $|A|_2$, the dependent of $|I|_1$, is simply suppressed. Then the resulting structure is phonetically interpreted as $eɪ$.

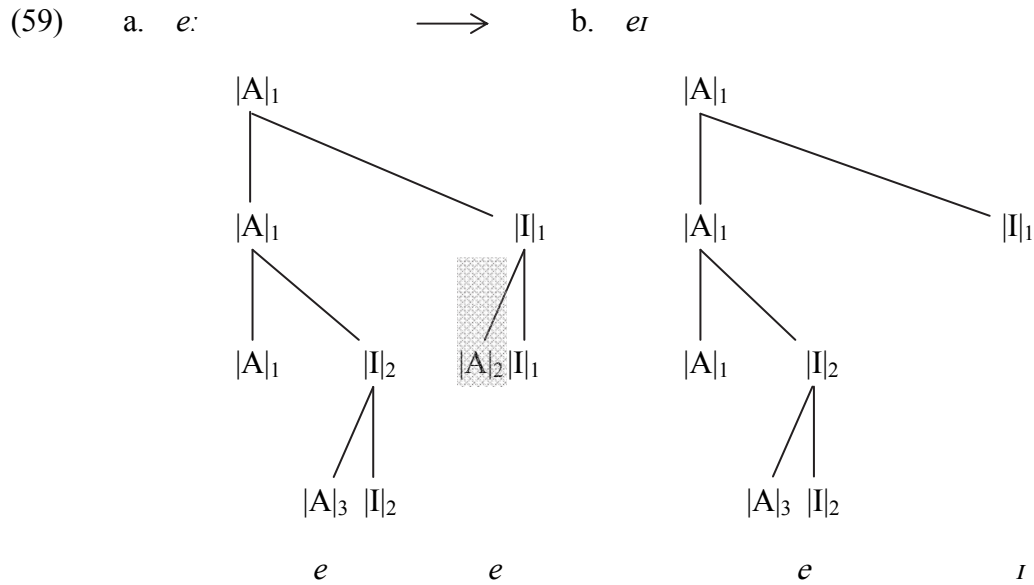

The development of $o:$ to $oʊ$ is accounted for in the same fashion, as illustrated below.

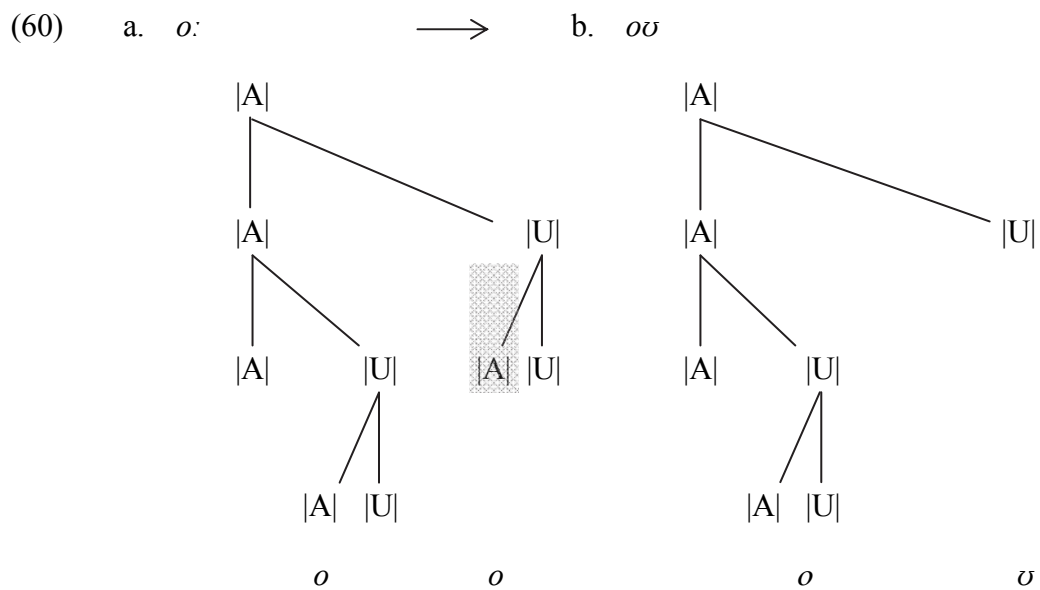

The next development of *ei* to *ai* in (58) is, unlike the above, not straightforward. In this process, |I|, the head of the most deeply embedded domain, is targeted for suppression. At the same time, the element |A|, the dependent of the |I| in the most deeply embedded domain, is duplicated in the same domain and they enter into a dependency relation. This may be considered to be the process which enhances the most deeply embedded element locally (within the lowest domain). As a result, as shown in (61b), the phonetic manifestation of the whole structure is *ai*.

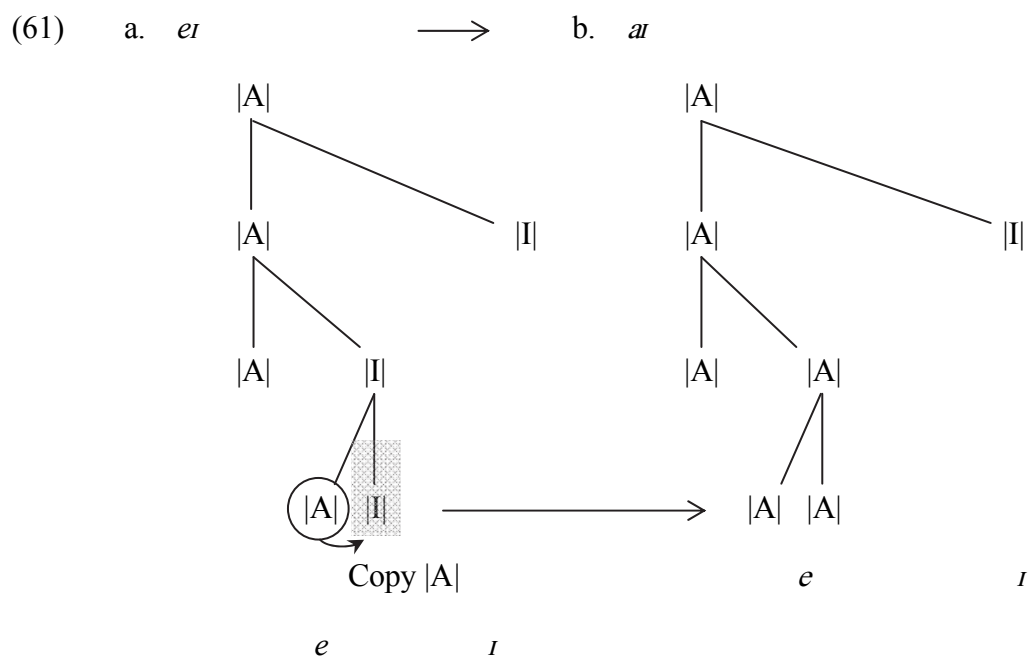

As shown in (62), the development of *ou* to *au* is also explained in the same manner.

(62) a. *oʊ*



b. *aʊ*

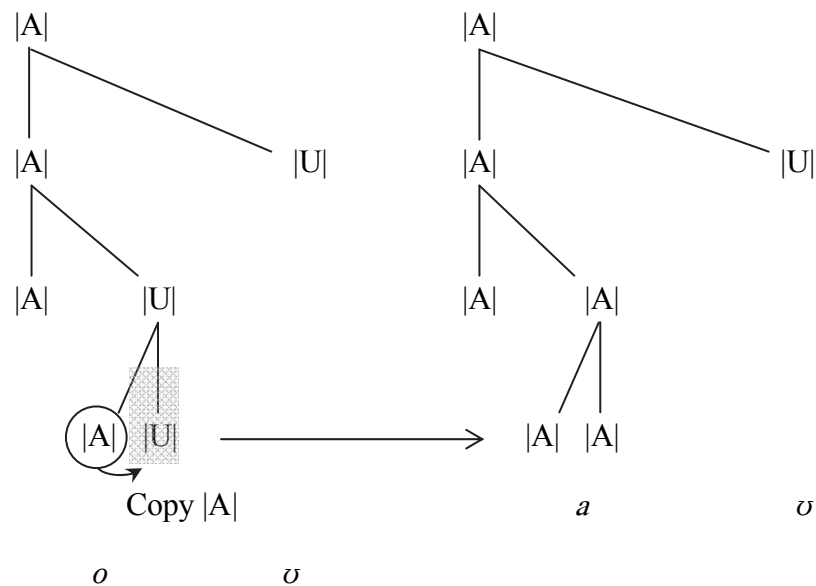

Thus, the patterns observed in diachronic and dialectal monophthongisation and diphthongisation processes in English are not straightforward. At least the following operations are confirmed. (Below $|\alpha|$ and $|\beta|$ may be one of the three elements |I U A|.)

- Copy $|\alpha|$ (to enhance the property)
- Make $|\alpha|$ dependent on $|\beta|$
- Make $|\alpha|$ dominant over $|\beta|$

Some phenomena employ only one of the three operations while others involve two or all of them. The choice of the operations and their variables (i.e., $|\alpha|$ and $|\beta|$) appears to be parametric.

4.8. Linearisation in Precedence-free Phonology

In standard Government Phonology, like other theories of phonological representation, precedence relations hold between segments, or, more precisely, between structural positions such as CV units, skeletal positions and Root nodes.

(63) *fæməli* ‘family’ in English (cf. Harris 1994: 191)

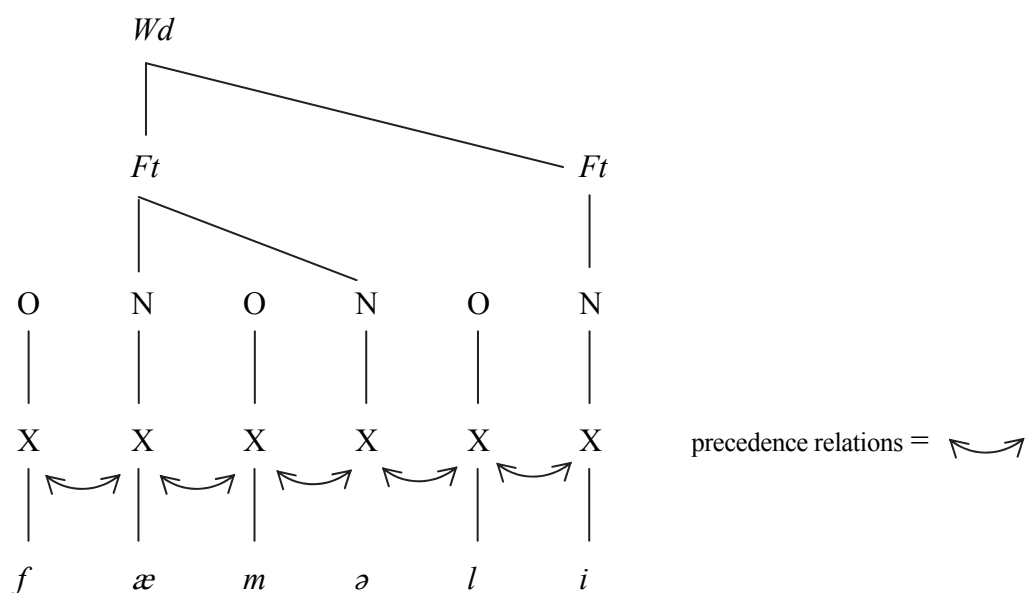

In this framework, in order to establish Proper Government in (64) (= (12) in Chapter 2), precedence relations hold not only between skeletal positions, but also between nuclei. The statement (64a) assures the existence of precedence relations between nuclei.

(64) Proper Government (Kaye 1990b: 314, Harris 1994: 191):

A nucleus α properly governs an empty nucleus β iff:

- a. α and β are adjacent on the nuclear projection.
- b. α is not itself p-licensed.
- c. α is not a government-licensor (for its onset).

As already discussed in section 2.3.2, in the English word ‘family’, conforming to (64a), the empty nucleus in the middle of the word is immediately followed by the adjacent word-final melodically filled nucleus at the level of nuclear projection. As illustrated in (65), in this case, the word-medial empty nucleus is p-licensed as a result of being properly governed by the final filled nucleus.

(65) *fæmli* ‘family’ in English (cf. Harris 1994: 191)

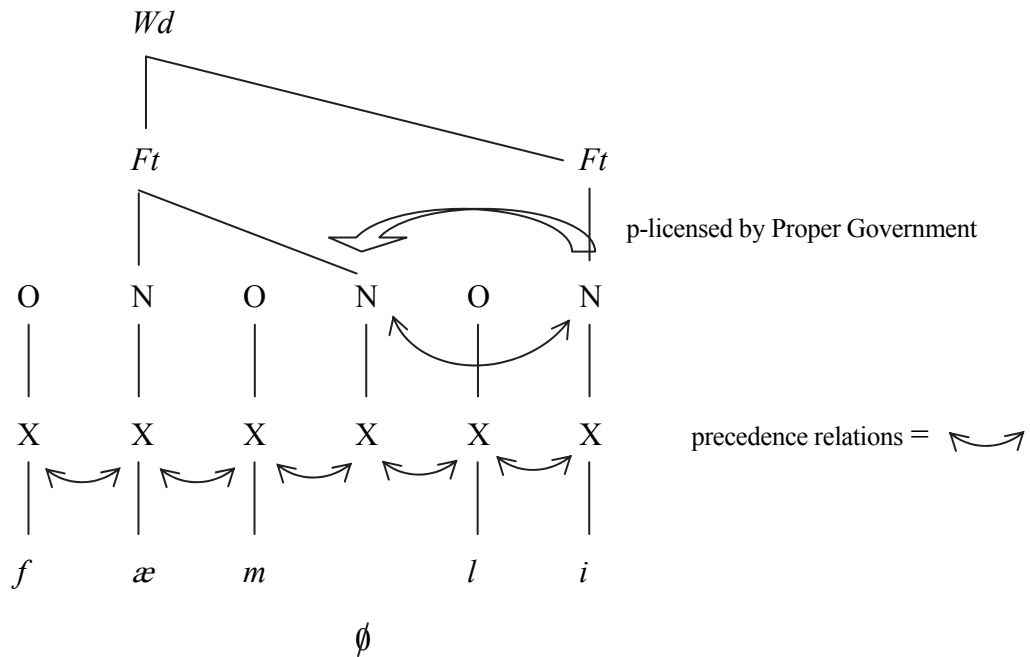

A p-licensed empty nucleus of this kind is not phonetically realised. As a result, *fæmæli* is pronounced as *fæmli*. Otherwise, the word-medial empty nucleus must receive phonetic interpretation of some kind, usually the central vowel ə. Thus in the case of English, unlike other languages such as Moroccan Arabic, Proper Government is parametric: some dialectal/accentual systems where it functions realise the form *fæmli* with no phonetic manifestation of the medial empty nucleus, whereas other dialectal/accentual systems with the OFF setting of the Proper Government parameter have *fæmæli* with the nucleus in question phonetically realised.

In Precedence-free Phonology, as the name implies, all properties associated with precedence are excluded from representations. And it is assumed that precedence is merely the natural result of computing and interpreting the dependency relations which hold between units (elements) in a structure. In this approach, for example, the English disyllabic word 'siti' 'city' is represented as follows.

(66) 'siti' 'city'

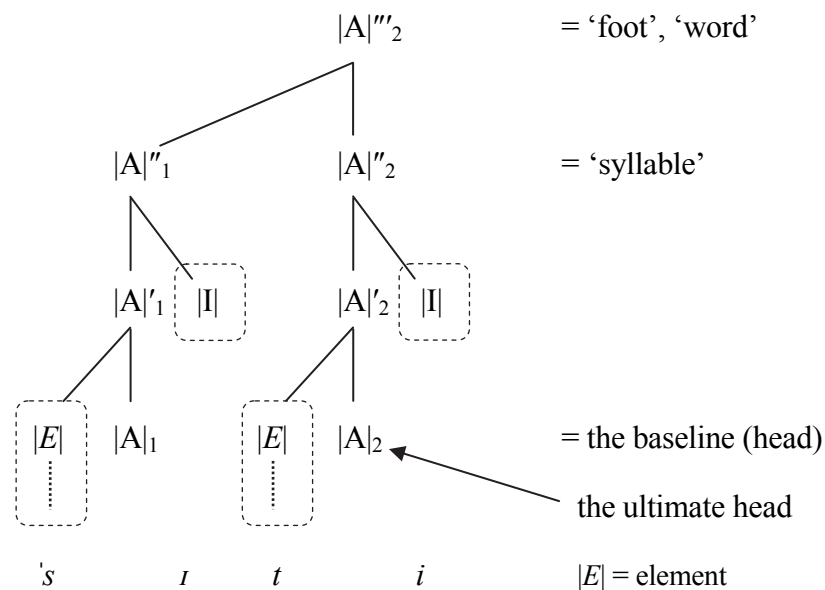

In the above configuration, $|A|_2$ is the ultimate head of the domain. It takes the consonantal set of elements for t as the dependent at the first level. The dependency relation between the consonantal set and the head (vowel element) is called *endocentric dependency* (67a) since the consonant set (C-type) has a different type of head $|A|$ (V-type). At the next level up, the set $|A|'_2$ (the $|A|$ -headed set of the C set and $|A|$) takes $|I|$ as a dependent. In contrast to the first level, this dependency relation is labelled *exocentric dependency* (67b) since the dependent $|I|$ has the same type (V-type) of head of the $|A|'_2$.

(67) Types of dependency

a. *Endocentric dependency*

If the dependent is of the same type as its head, this is endocentric dependency.

b. *Exocentric dependency*

If the dependent is of a different type from its head, this is exocentric dependency.

The same configuration is found in the structure for *sr* of 'siti: $|A|''_1$ contains (i) the $|A|'_1$ -headed set of $|A|'_1$ and $|I|$ and (ii) the set $|A|'_1$ consists of the $|A|$ -headed set of the consonantal set and $|A|$. The dependency relation (i) between $|A|'_1$ and $|I|$ is *endocentric* while the relation (ii) between the consonantal set and $|A|$ is *exocentric*.

At the top of the asymmetric hierarchical structure, $|A|''_1$ and $|A|''_2$ are concatenated. The former ($|A|''_1$), which receives primary stress and is therefore more prominent, is the dependent while the latter ($|A|''_2$) is the head since a unit which is

deeply embedded is structurally recessive but phonetically rich (prominent). Thus no properties associated with precedence are encoded in the structure.

Let us now address the question of how precedence is derived through computing and interpreting the dependency relations which hold between units in a structure. An argument developed in Takahashi (2004) (cf. Nasukawa 2011) proposes that the mapping between dependency relations and their phonetic manifestation is defined in terms of linearization.

(68) Takahashi (2004: 172)

a. Endocentric dependency: if $\alpha \rightrightarrows \beta$, then $\alpha \ll \beta$

In endocentric dependency wherein α and β are the head and the dependent position, respectively, α strictly and immediately precedes β in phonetic interpretation.

b. Exocentric dependency: if $\alpha \rightarrow \beta$, then $\alpha > \beta$

In exocentric dependency wherein α and β are the head and the dependent position, respectively, α strictly but not necessarily immediately follows β in phonetic interpretation.

Under this view, representations (69a) and (69b), which display endocentric dependency, have the same phonetic manifestation. On the other hand, since (69c) is formed by exocentric dependency, the structure is phonetically realised as *ja* rather than *ai*.

(69) a. Endocentric dep b. Endocentric dep c. Exocentric dep

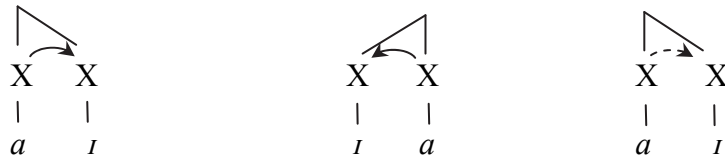

In the structure of 'siti' 'city' in (70) (= (4)), units (which are different in type) at the lowest level enter into an endocentric dependency relation, this configuration being phonetically interpreted as a head preceding its dependent along the time axis. At the next level up, for example, $|A|'_2$ and $|I|$ enter into an exocentric dependency relation and they are phonetically realised as a dependent preceding its head. Then at the highest level, $|A|''_1$ and $|A|''_2$ enter into an exocentric dependency even though $|A|''_1$ is of the same type as $|A|''_2$. In stress-accented languages like English, the dependency relation between units that form a set higher than the $|A|''$ (= $|A|'''$, traditionally referred to as *foot*) is assumed to be always exocentric.

(70) 'siti' 'city'

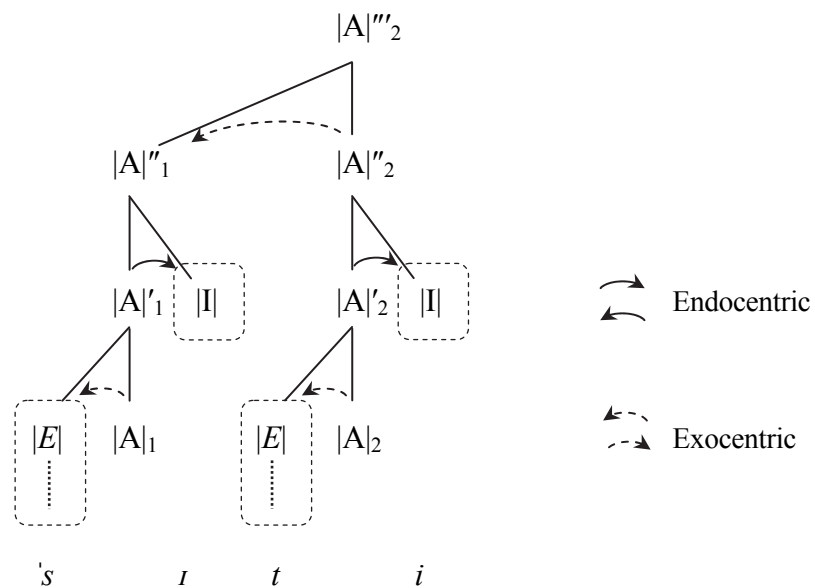

According to Nasukawa (2011: 290-291), like the syntactic-tree-traversal algorithms in Kural (2005), the above mapping process first takes place at the highest dependency level, then moves down in turn to the lower levels in a structure. In this way, the linear ordering of sets is established in phonetic terms.

In this framework, like the standard Government Phonology, monosyllabic words such as *sit* ‘sit’ in (71) are considered to have the same structure as disyllabic words such as *'siti* ‘city’ in (70).

(71) *sit* ‘sit’

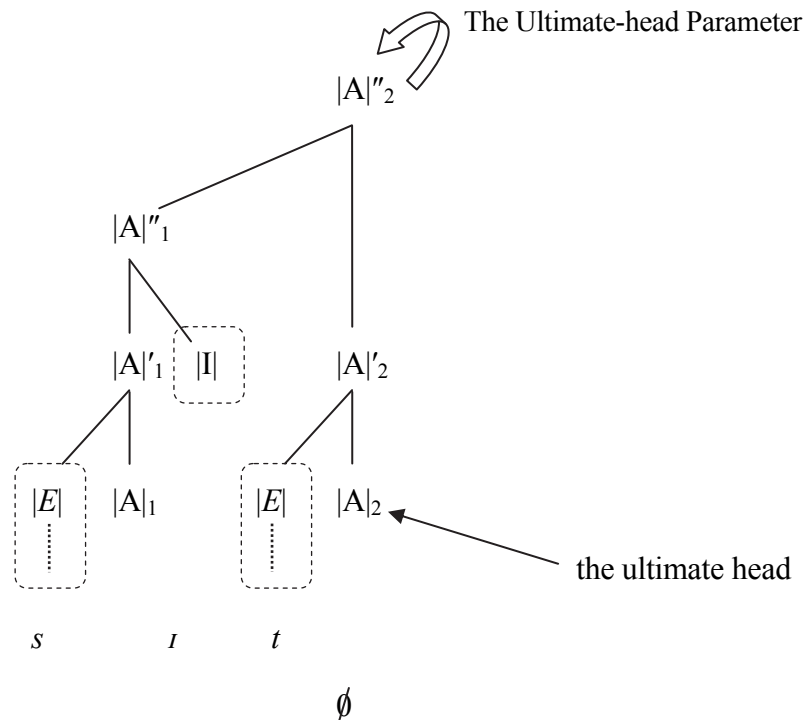

One difference between the structures for *sit* ‘sit’ and *'siti* ‘city’ concerns the status of the ultimate head $|A|_2$: $|A|_2$ in (71) has no dependent at the $|A|''_2$ level while $|A|_2$ in (70) has $|I|$ as its dependent at the $|A|''_2$ level. In the case of the monosyllabic word *sit* ‘sit’, $|A|_2$ behaves like (in traditional terms) a domain-final empty nucleus. In order to suppress the phonetic manifestation of $|A|_2$, the theory assumes a device similar to the

Domain-final-empty-nucleus Parameter. Given that this Parameter is inappropriate in a precedence-free approach to phonology, since it refers to precedence-related terms such as ‘final’, as discussed in section 4.4.1, I assume the following parameter.

(72) The Ultimate-head Parameter (UHP) (= (21))

When the ultimate head element of a given domain has no dependent in its vocalic part, the ultimate head element is p-licensed [OFF/ON]

In the case of *sit* ‘sit’, the ultimate head $|A|_2$, which has no dependent element in its vocalic part (at the $|A|''_2$ level), receives no phonetic interpretation.

In this precedence-free model of phonological representation, Proper Government is also called upon. However, it functions without referring to precedence relations between nuclei.

(73) Proper Government (precedence-free model version):

A head α properly governs a head β which has no V-type dependent iff:

- a. α is at one level higher than β in a given structure .
- b. α is not itself p-licensed.

In the case of the English word ‘family’, $|A|_3$ (which has $|I|$ as its V-type dependent) is structurally specified at one level higher than $|A|_2$ in the middle (which has no V-type dependent), as illustrated below.

(74) 'fæmli' 'family'

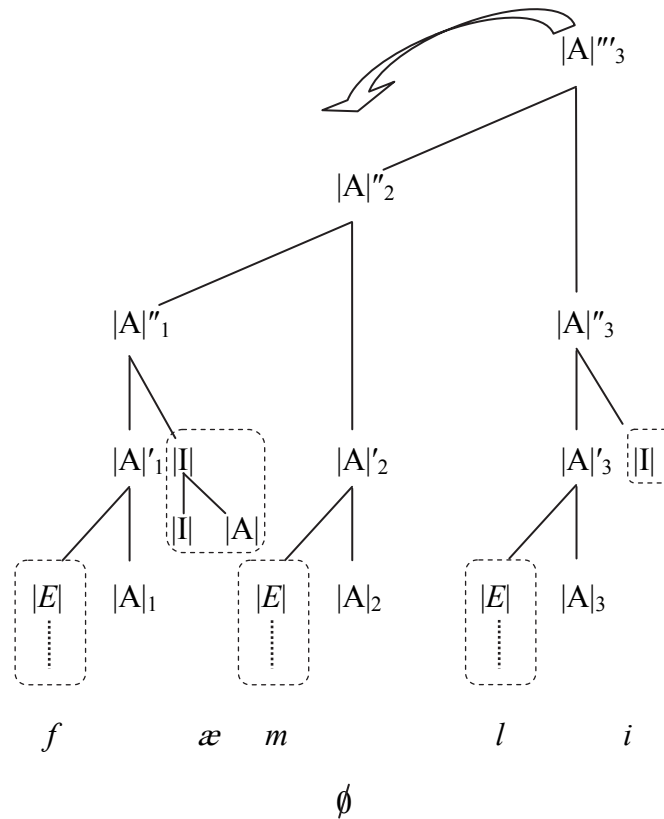

In such a case, in accordance with (73a), $|A|_2$ in the middle is p-licensed by being properly governed by $|A|_3$, giving (74) in which the p-licensed $|A|_2$ receives no phonetic interpretation. As a result, *fæmali* is phonetically interpreted as *fæmli*. Otherwise, $|A|_2$ has to be phonetically realised as the English central vowel æ .

4.9. Summary

I began this chapter by arguing how the two relational properties of precedence and dependency have been incorporated into phonological representations. Then, following arguments provided by Nasukawa (2011, 2014, 2015ab) and in an attempt to conform to

representational minimalism, I have adopted the approach taken by Precedence-free Phonology, whereby the notion of precedence is formally eliminated from phonological representations and phonological structure is represented by only dependency relations between units.

In Precedence-free Phonology, since units (e.g. timing units, CV units, skeletal positions, onsets, nuclei, rhymes) which are associated with precedence are all absent from representations, the only remaining units are phonological primitives (features: minimal contrastive units). The primitives adopted in this framework are those developed within Element Theory (Harris 1994, 2005; Harris and Lindsey 1995, 2000; Nasukawa and Backley 2008, Backley 2011), elements being components of UG, single-valued (monovalent), and phonetically interpretable in isolation. In this approach, it is these elements rather than syllabic constituents that are regarded as the building blocks of phonological structure. Then, the nucleus (which is generally considered to play a central role in structure-building) is replaced by one of the three resonance elements |A|, |I| or |U|, one of them determining the quality of an empty nucleus: |A| is phonetically interpreted as *ə* in English, |I| as *i* in Fijian and |U| as *u* in Japanese.

In this framework, one of the three elements |A I U| plays a role as the baseline or the ultimate head for building structure. In the case of English, the baseline is |A|. When the structure is formed by only |A| it is phonetically realised as schwa, the most central vowel in the language. Then when the head |A| takes |A|, |I| or |U| as a dependent, the acoustic signature of the baseline is masked by those elements and the overall structure is phonetically interpreted as *ə*, *i* or *u* respectively.

Elements not only serve as the building blocks of phonological structure but they also combine freely to make melodic expressions. In the representation of the mid front vowels *e* and *æ*, for example, they are the phonetic realisation of the |A|-headed set

of |A I| and the |I|-headed set of |A I| respectively. The same asymmetric relations between constituent elements are found in the structure of the mid back vowels *o* and *ɔ*. In the relevant section of this chapter, I proposed the representations of the other vowels of English by referring only to dependency relations between elements.

In order to validate the proposed element structures for English vowels, various phonological phenomena observed in English were analysed by employing operations which do not refer to precedence. The final part of this chapter then discussed the status of parametric devices such as Proper Government and the Domain-final-empty-nucleus Parameter, which refer to precedence relations between units in the Government Phonology framework. I conclude that they can be incorporated into the precedence-free approach to phonology in a different form: they are replaced by a precedence-free version of Proper Government and the Ultimate-head Parameter, both of which do not need to refer to precedence relations between units.

5 *Conclusion*

5.1. Summary

In response to some theoretically disputed points concerning the status of empty nuclei, this study has developed a precedence-free model of vowel representation which refers only to dependency relations between elements (minimal contrastive units), eliminating all categories/constituents associated with precedence. In this approach, precedence is not regarded as a formal property of grammar; rather, it is viewed as a by-product of phonetic interpretation executed by the Articulatory-Perceptual systems.

In Precedence-free Phonology, the elements |A I U|, rather than syllabic constituents such as onsets, nuclei and rhymes, are regarded as the basic units used for building phonological structure. Then, the nucleus (which, in other phonological theories, plays a key structural role) is replaced by one of the three resonance elements |A I U|, one of them determining the quality of the baseline resonance in a given language and serving as the ultimate head of every phonological structure: for example, baseline |A| is phonetically interpreted as *ə* in French, |I| as *i* in Fijian, and |U| as *u* in Japanese. These vowels are cross-linguistically observed as default epenthetic vowels in the nativisation of loanwords.

In the case of English, |A| is its baseline element, so the structure consisting of a single |A| is phonetically realised as *ə* (or *ɪ* in some dialects).

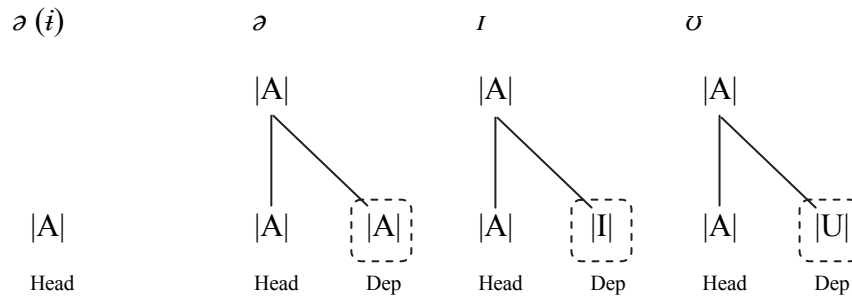

Then, when a head |A| (baseline) takes |A|, |I| or |U| as its dependent, the acoustic signature of the baseline is masked by the acoustic patterns of those additional elements and the overall structure is phonetically interpreted as ə, i or u respectively.

It should be noted that there are two distinct representations for ə in English: (i) the set containing only a single |A| (the leftmost structure above) and (ii) the |A|-headed set of two |A|s (second from the left). The former displays vowel-zero alternations (e.g., *fæməli-fæmli* ‘family’, *rʌʃ* ‘rush’ + -z PL → *rʌʃəz* or sometimes *rʌʃɪz* in some dialects), its structure being suppressed when it is p-licensed; otherwise it must be phonetically realised. On the other hand, the latter is involved in vowel reduction, in which full vowels become ə (or ɪ) in unstressed positions (e.g., *kənt* ‘content’ ADJ - ‘*kɒntent* ‘content’ NOUN): all elements except |A| are deleted in unstressed positions and the resulting structure (which has only a single |A|) phonetically manifests itself as ə. Other languages also have two distinct structures for the phonetically identical vowel (e.g., Japanese has the set containing only a single |U| (the baseline) and the |U|-headed set of two |U|s).

In fact, vowel sonority is associated with the number of tokens of |A| present in a structure, following Particle Phonology (Schane 1984, 1995, 2005): the more |A|s there are, the more sonorous the vowel expression is. In comparison with the |A|-headed set of two |A|s for ə, the |A|-headed set of three |A|s phonetically manifests itself as ʌ, which has a higher degree of sonority than ə. This is depicted in the leftmost representation below.

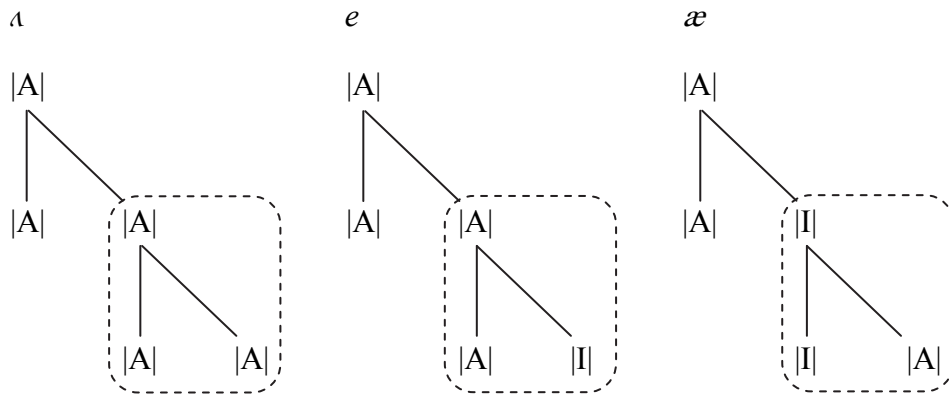

In order to create further vocalic expressions, elements may be combined freely. For example, the mid front vowels *e* and *æ* are, respectively, the phonetic manifestation of the $|A|$ -headed set of $|A I|$ (as in the middle structure above) and the $|I|$ -headed set of $|A I|$ (as in the rightmost structure above). The same asymmetric relations between constituent elements are found in the structures for the mid back vowels *o* and *ɔ*. To represent other vowels, these sets can be dominated by another set: for example, the $|A|$ -headed set of $|I|$ and $|A|$ ($[|A|[[I]|A|]]$) which is dominated by the set consisting of only $|I|$ ($[|I|]$) is interpreted as the closing diphthong *ei*. This kind of recursive structure is also employed in the representation of other vowels in English.

In order to validate the proposed precedence-free structure for the vowels of English, vocalic phonological phenomena observed in English have been analysed by using devices such as Proper Government and the Ultimate-head Parameter, which do not refer to precedence relations between units.

5.2. Further remarks

Replacing an empty nucleus with an element-based precedence-free structure raises a number of general issues that merit further research. First, how are vowels in languages other than English to be represented in this model? Second, how are the proposed structures to be extended to consonant representations? Third, how is the overall approach adopted in this study to be evaluated against other approaches such as GP 2.0 (Pöchtrager 2006, 2015)? Although the GP2.0 model eliminates |A| from representations, it nevertheless employs structures which are in many respects similar to those developed in the present model. (Note, however, that unlike the present study, the GP2.0 model represents schwa and varying degrees of sonority by the number of empty structures.)

The next stage of this project will look further afield and address the above issues. This will lend valuable support to the arguments set out in this thesis.

Appendix

A. Chomsky and Halle's Distinctive Features (Chomsky and Halle 1968, cf., Clark and Yallop 1990: 365, Oishi and Nasukawa 2011: 100)

<i>Feature</i>	<i>Articulatory description</i>
<i>Major class features</i>	
1 Sonorant	Produced with vocal tract cavity configuration in which spontaneous voicing is possible
2 Vocalic	Constriction does not exceed that of high vowels, and position of vocal folds allows spontaneous voicing
3 Consonantal	Radical obstruction in mid-sagittal region of vocal tract
<i>Cavity features</i>	
4 Coronal	Produced with blade of tongue raised from neutral position
5 Anterior	Produced with obstruction in front of palato-alveolar region
6 High	Tongue body above neutral position
7 Low	Tongue body below neutral position
8 Back	Tongue body retracted from neutral position
9 Round(ed)	Narrowed of lip orifice
10 Distributed	Constriction extends for some distance along direction of airflow
11 Covered	Pharynx walls narrowed and tensed and larynx raised (in vowel production)
12 Glottal constriction	Constriction of vocal folds
13 Nasal	Lowered velum
14 Lateral	Lowered side(s) of mid-section of tongue
<i>Manner of articulation features</i>	
15 Continuant	Primary constriction in vocal tract does not block air flow
16 Instantaneous release	Instantaneous release (of stops)
17 Velar(ic) suction	Velar closure producing suction (clicks)
18 Implosion	Glottal closure producing suction (implosives)
19 Velar(ic) pressure	(Velar closure producing pressure — no evidence of use in language)
20 Ejection	Glottal closure producing pressure (ejectives)
21 Tense	Deliberate, accurate, maximally distinct articulation (of supraglottal musculature)
<i>Source features</i>	
22 Hightened subglottal pressure	Tenseness in subglottal musculature producing greater subglottal pressure
23 Voiced	Vocal fold vibration (induced by appropriate glottal opening and airflow)
24 Strident	Turbulence (in fricatives and affricates) caused by nature of surface, rate of airflow and angle of incidence at point of articulation
<i>Prosodic features</i> (listed but not discussed in Chomsky & Halle 1968)	
25 Stress	
26 Pitch (high, low, elevated, rising, falling, concave)	
27 Length	

B. Components in Dependency Phonology (Anderson and Ewen 1987, cf. Clark and Yallop 1990: 367, Oishi and Nasukawa 2011: 101-102)

<i>Gesture</i>	<i>Subgesture</i>	<i>Components</i>
Categorial	Phonatory	Consonantality or periodicity: a scale ranging from V 'relatively periodic' to C 'periodic energy reduction'
	Initiatory	Degree of glottal opening: a scale encompassing aspiration as well as voicing, represented by the extent to which a component O is prominent; O is absent in the glottal stop G glottalicness (in glottalic sounds, absent in pulmonic) K velaricness (present in clicks, absent for other sounds)
Articulatory	Locational	i frontness (acuteness, sharpness) a lowness (sonority) u roundness (gravity, flatness) ə centrality l linguality (present in sounds in which the blade or body of the tongue is active) t apicality d dentality r retracted tongue root (present in pharyngeal consonants and in vowels with narrowed pharynx) α advanced tongue root (relevant only to languages which distinguish vowels with advanced tongue root from vowels with neutral tongue root posture)
	Oro-nasal	λ laterality n nasality

C. Elements (Harris and Lindsey 1995, 2000; cf., Oishi and Nasukawa 2011: 102)

<i>Element</i>	<i>Pattern</i>	<i>Acoustic pattern</i>	<i>Articulatory execution</i>
<i>Resonance elements</i>			
[A]	mAss	Central spectral energy mass (Convergence of F1 and F2)	Maximal expansion of oral tube; maximal constriction of pharyngeal tube
[I]	dIp	Low F1 coupled with high spectral peak (Convergence of F2 and F3)	Maximal constriction of oral tube; maximal expansion of pharyngeal tube
[U]	rUmp	Low spectral peak (Convergence of F1 and F2)	Trade-off between expansion of oral and pharyngeal tubes
[R]	rise	High spectral peak	Articulation with the tip or the blade of the tongue (Coronality)
Base-line for resonance elements:			
@	neutral	No salient spectral peak	Neutral expansion of oral tube; neutral constriction of pharyngeal tube (centrality and velarity)
<i>'Manner' elements</i>			
[ʔ]	edge	Abrupt and sustained drop in overall amplitude	Occlusion in oral cavity
[h]	noise	Aperiodic energy	Narrowed stricture producing turbulent airflow
[N]	murmur	Broad resonance peak at lower end of the frequency range	Lowering of the velum
<i>Source elements</i>			
[H]	high source	F0 up	Slack vocal folds
[L]	low source	F0 down	Spread vocal folds

D. Phonetic symbols

THE INTERNATIONAL PHONETIC ALPHABET (revised to 1993, updated 1996)

CONSONANTS (PULMONIC)

	Bilabial	Labiodental	Dental	Alveolar	Postalveolar	Retroflex	Palatal	Velar	Uvular	Pharyngeal	Glottal
Plosive	p b			t d		ʈ ɖ	c ɟ	k ɡ	q ɢ		ʔ
Nasal	m	ɱ		n		ɳ	ɲ	ŋ	ɴ		
Trill	ʙ			r					ʀ		
Tap or Flap				ɾ		ɽ					
Fricative	ɸ β	f v	θ ð	s z	ʃ ʒ	ʂ ʐ	ç ʝ	x ɣ	χ ʁ	ħ ʕ	h ɦ
Lateral fricative				ɬ ɮ							
Approximant		ʋ		ɹ		ɻ	j	ɰ			
Lateral approximant				l		ɭ	ʎ	ʟ			

Where symbols appear in pairs, the one to the right represents a voiced consonant. Shaded areas denote articulations judged impossible.

CONSONANTS (NON-PULMONIC)

Clicks	Voiced implosives	Ejectives
◌ ɓ	◌ ɗ	◌ ʼ Examples:
◌ ɠ	◌ ɡ	◌ ɸ Bilabial
◌ ɥ	◌ ʘ	◌ ɬ Dental/alveolar
◌ ɮ	◌ ʙ	◌ ɰ Palatal
◌ ɰ	◌ ɓ	◌ ɣ Dental/alveolar
◌ ɱ	◌ ɗ	◌ ɰ Velar
◌ ɲ	◌ ɡ	◌ ʂ Alveolar fricative
◌ ɳ		

OTHER SYMBOLS

ɱ	Voiceless labial-velar fricative	ç ʝ	Alveolo-palatal fricatives
ʋ	Voiced labial-velar approximant	ɺ	Alveolar lateral flap
ɰ	Voiced labial-palatal approximant	ɥ	Simultaneous ʃ and x
ħ	Voiceless epiglottal fricative		
ʕ	Voiced epiglottal fricative		Affricates and double articulations can be represented by two symbols joined by a tie bar if necessary.
ʔ	Epiglottal plosive		

VOWELS

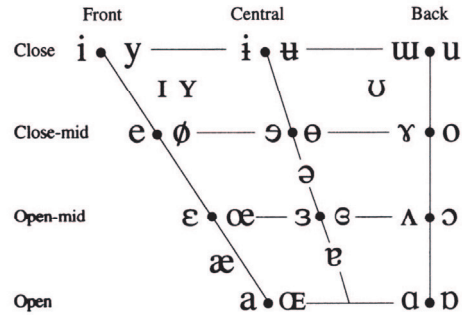

Where symbols appear in pairs, the one to the right represents a rounded vowel.

SUPRASEGMENTALS

ˈ	Primary stress
ˌ	Secondary stress
ː	Long
ˑ	Half-long
◌̥	Extra-short
◌̜	Minor (foot) group
◌̚	Major (intonation) group
◌̣	Syllable break
◌̤	Linking (absence of a break)

TONES AND WORD ACCENTS

LEVEL	CONTOUR
é̊ or ɤ̊	Extra high
é̎	High
ē	Mid
è	Low
è̋	Extra low
↓	Downstep
↑	Upstep
e or ɤ	Rising
ē	Falling
ē̎	High rising
ē̋	Low rising
ẹ̄	Rising-falling
↗	Global rise
↘	Global fall

DIACRITICS Diacritics may be placed above a symbol with a descender, e.g. ɲ̄

◌̥	Voiceless	◌̤	Breathy voiced	◌̦	Dental
◌̧	Voiced	◌̨	Creaky voiced	◌̩	Apical
◌̨	Aspirated	◌̪	Linguolabial	◌̫	Laminal
◌̩	More rounded	◌̬	Labialized	◌̭	Nasalized
◌̪	Less rounded	◌̮	Palatalized	◌̯	Nasal release
◌̫	Advanced	◌̰	Velarized	◌̱	Lateral release
◌̬	Retracted	◌̲	Pharyngealized	◌̳	No audible release
◌̭	Centralized	◌̴	Velarized or pharyngealized		
◌̮	Mid-centralized	◌̵	Raised		
◌̯	Syllabic	◌̶	Lowered		
◌̰	Non-syllabic	◌̷	Advanced Tongue Root		
◌̱	Rhoticity	◌̸	Retracted Tongue Root		

References

- Abaglo, Poovi and Diana Archangeli. (1989). Language particular underspecification: Gengbe /e/ and Yoruba /i/. *Linguistic Inquiry* 20: 457-480.
- Akinlabi, Akinbiyi. (1993). Underspecification and the phonology of Yoruba /r/. *Linguistic Inquiry* 24: 139–160.
- Anderson, John M. and Colin J. Ewen. (1981). The representation of neutralization in universal phonology. In Wolfgang U. Dressler, Oskar E. Pfeiffer and John R. Rennison (eds.), *Phonologica 1980*, 15-22. Innsbruck: Innsbrucker Beiträge zur Sprachwissenschaft.
- Anderson, John M. and Colin J. Ewen. (1987). *Principles of Dependency Phonology*. Cambridge: Cambridge University Press.
- Anderson, John M. and Charles Jones. (1974). Three theses concerning phonological representations. *Journal of Linguistics* 10: 1-26.
- Anderson, John M. and Charles Jones. (1977). *Phonological Structure and the History of English*. Amsterdam: North-Holland.
- Anderson, Stephen R. (1982). The analysis of French schwa. *Linguistic Inquiry* 58 (3): 532-573.
- Anderson, Stephen R. (1985). *Phonology in the Twentieth Century*. Chicago: University of Chicago Press.
- Archangeli, Diana. (1984). *Underspecification in Yawelmani Phonology and Morphology*. Doctoral dissertation, Massachusetts Institute of Technology. Published in 1988, New York: Garland Publishing.
- Archangeli, Diana. (1988). Aspects of underspecification theory. *Phonology* 5: 183-205.

- Archangeli, Diana and Douglas Pulleyblank. (1994). *Grounded Phonology*. Cambridge, MA: MIT Press.
- Aronoff, Mark. (1976). *Word Formation in Generative Grammar*. Cambridge, MA: MIT Press.
- Backley, Phillip. (2011). *An Introduction to Element Theory*. Edinburgh: Edinburgh University Press.
- Backley, Phillip. (2012). Variation in Element Theory. *Linguistic Variation* 12 (1): 57-102.
- Backley, Phillip and Kuniya Nasukawa. (2009). Headship as melodic strength. In Kuniya Nasukawa and Phillip Backley (eds.), *Strength Relations in Phonology*, 47-77. Berlin and New York: Mouton de Gruyter.
- Backley, Phillip and Kuniya Nasukawa. (2010). Consonant-vowel unity in Element Theory. *Phonological Studies* 13: 21-28.
- Backley, Phillip and Toyomi Takahashi. (1998). Element activation. In Eugeniusz Cyran (ed), *Structure and Interpretation: Studies in Phonology*, 13-40. Lublin: Folium.
- Batibo, Herman M. (1995). Loanword clusters nativization rules in Tswana and Swahili. *South African Journal of African Languages* 16 (2): 33-41.
- Bickmore, Lee S. (2007). *Cilungu Phonology*. Stanford, CA: Center for the Study of Language and Information.
- Brakel, Arthur. (1983). *Phonological Markedness and Distinctive Features*. Bloomington: Indiana University Press.
- Bresnan, Joan. (1982). *The Mental Representation of Grammatical Relations*. Cambridge, MA: MIT Press.
- Broadbent, Judith. (1991). Linking and intrusive r in English. *UCL Working Papers in Linguistics* 3: 281-302.

- Brockhaus, Wiebke. (1995). Skeletal and suprasegmental structure within government phonology. In Jacques Durand and Francis Katamba (ed.), *Frontiers of Phonology: Atoms, Structures, Derivations*, 180-221. Harlow, Essex: Longman.
- Brombueger, Sylvain and Morris Halle. (1989). Why phonology is different. *Linguistic Inquiry* 20: 51-70.
- Browman, Catherine P. and Louis M. Goldstein. (1989). Articulatory gestures as phonological units. *Phonology* 6: 201-252.
- Browman, Catherine P. and Louis M. Goldstein. (1990). Tiers in articulatory phonology, with some implications for casual speech. In John Kingston and Mary E. Beckman (eds.), *Papers in Laboratory Phonology I: Between the Grammar and Physics of Speech*, 341–76. Cambridge: Cambridge University Press.
- Browman, Catherine P. and Louis M. Goldstein. (1992). ‘Targetless’ schwa: an articulatory analysis. In Gerard J. Docherty and D. Robert Ladd (eds.), *Papers in Laboratory Phonology II: Gesture, Segment, Prosody*, 26-56. Cambridge: Cambridge University Press.
- Burridge, Kate. (2004). *Blooming English: Observations on the Roots, Cultivation and Hybrids of the English Language*. Cambridge: Cambridge University Press.
- Burzio, Luigi. (1994). *Principles of English Stress*. Cambridge: Cambridge University Press.
- Byarushengo, Ernest Rugwa. (1976). Strategies in loan phonology. *Proceedings of the 2nd Annual Meeting of the Berkeley Linguistics Society*, 78–88. Berkeley, CA: Berkeley Linguistics Society.

- Byarushengo, Ernest Rugwa, Larry M. Hyman and Sarah Tenenbaum. (1976). Tone, accent, and assertion in Haya. In Larry M. Hyman (ed.), *Studies in Bantu Tonology, Southern California Occasional Papers in Linguistics (SCOPIL)* 3, 185-205. Los Angeles: University of Southern California.
- Bybee, Joan. (2001). *Phonology and Language Use*. Cambridge: Cambridge University Press.
- Cain, Horst. (1986). *A Lexicon of Foreign Loan-Words in the Samoan Language*. Köln: Böhlau Verlag.
- Calabrese, Andrea. (1988). *Towards a Theory of Phonological Alphabets*. Doctoral dissertation, Massachusetts Institute of Technology. Cambridge, MA: Massachusetts Institute of Technology.
- Calabrese, Andrea. (2005). *Markedness and Economy in a Derivational Model of Phonology*. Berlin: Walter de Gruyter.
- Carr, Philip. (1993). *Phonology*. London: Macmillan.
- Charette, Monik. (1990). Licence to govern. *Phonology* 7: 233-253.
- Charette, Monik. (1991). *Conditions on Phonological Government*. Cambridge: Cambridge University Press.
- Charette, Monik. (1998). Empty and pseudo-empty categories. *SOAS Working Papers in Linguistics and Phonetics* 8: 167-176.
- Chomsky, Noam. (1957). *Syntactic Structures*. The Hague: Mouton.
- Chomsky, Noam. (1981). *Lectures on Government and Binding*. Dordrecht: Foris.
- Chomsky, Noam. (1982). *Some Concepts and Consequences of the Theory of Government and Binding*. Cambridge, MA: MIT Press.
- Chomsky, Noam. (1986). *Knowledge of Language: Its Nature, Origin, and Use*. New York: Praeger.

- Chomsky, Noam. (1993). A Minimalist Program for linguistic theory. In Ken Hale and Samuel J. Keyser (eds.), *The View From Building 20*, 1-52. Cambridge, MA: MIT Press.
- Chomsky, Noam. (1995). *The Minimalist Program*. Cambridge, MA: MIT Press.
- Chomsky, Noam and Morris Halle. (1968). *The Sound Pattern of English*. New York: Harper and Row.
- Clark, John and Colin Yallop. (1990). *An Introduction to Phonetics and Phonology*. Oxford: Blackwell.
- Clements, George N. (1985). The geometry of phonological features. *Phonology Yearbook 2*: 225-252.
- Clements, George N. (1991). Place of articulation in consonants and vowels: a unified theory. *Working Papers of the Cornell Phonetics Laboratory 5*: 77-123.
- Clements, George N. and Elizabeth V. Hume. (1995). The internal structure of speech sounds. In John A. Goldsmith (ed.), *Handbook of Phonological Theory*, 245-306. Oxford: Blackwell.
- Clements, George N. and Samuel J. Keyser. (1983). *CV Phonology: a Generative Theory of the Syllable*. Cambridge, MA: MIT Press.
- Coleman, John. (1990a). Charm theory defines strange vowel sets. *Journal of Linguistics* 26: 165-174.
- Coleman, John. (1990b). Vowel sets: a reply to Kaye. *Journal of Linguistics* 26: 183-187.
- Coleman, John. (1998). *Phonological Representations: Their Names, Forms and Powers*. Cambridge: Cambridge University Press.
- Coleman, John. (2003). Discovering the acoustic correlates of phonological contrasts. *Phonetica* 31: 351-372.

- Crosswhite, Katherine. (2001). *Vowel Reduction in Optimality Theory*. New York: Routledge.
- Crosswhite, Katherine. (2004). Vowel reduction. In Bruce Hayes, Robert Kirchner and Donca Steriade (eds.), *Phonetically Based Phonology*, 191-231. Cambridge: Cambridge University Press.
- Cruttenden, Alan. (2001). *Gimson's Pronunciation of English*. 6th edition. London: Edward Arnold.
- Cyran, Eugeniusz. (1997). *Resonance Elements in Phonology: A Study in Munster Irish*. Lublin, Poland: Wydawnictwo Folium.
- Cyran, Eugeniusz. (2010). *Complexity Scales and Licensing in Phonology*. Berlin and New York: Mouton de Gruyter.
- de Lacy, Paul. (2006). *Markedness*. Cambridge: Cambridge University Press.
- Diehl, Randy L. (1991). The role of phonetics within the study of language. *Phonetica* 48: 120-134.
- Donegan, Patricia J. (1978). On the natural phonology of vowels. Doctoral dissertation, Ohio State University. Published in *Working Papers in Linguistics* 23. Columbus, OH: Ohio State University Department of Linguistics. (Also published in 1985 in the series *Outstanding Dissertations in Linguistics*, New York: Garland Publishing)
- Donegan, Patricia J. and David Stampe. (1979). The study of natural phonology. In Daniel A. Dinnsen (ed.), *Current Approaches to Phonological Theory*, 126-173. Bloomington: Indiana University Press.
- Durand, Jacques. (1990). *Generative and Non-linear Phonology*. Harlow: Longman.
- Durand, Jacques. (1995). Universals in phonology: atoms, structures and derivations. In Jacques Dorand and Francis Katamba (eds.), *Frontiers of Phonology: Atoms, Structures, Derivations*, 267-288. Harlow: Longman.

- Durand, Jacques. (2005). Tense/lax, the vowel system of English and phonological theory. In Philip Carr, Jacques Durand and Colin J. Ewen (eds.), *Headhood, Elements, Specification and Contrastivity*, 119-132. Amsterdam and Philadelphia: John Benjamins.
- Ewen, Colin J. (1994). Dependency relations in phonology. In John A. Goldsmith (ed.), *A Handbook of Phonological Theory*, 570-585. Oxford: Blackwell.
- Ewen, Colin J. and Harry van der Hulst. (2001). *The Phonological Structure of Words*. Cambridge: Cambridge University Press.
- Flemming, Edward. (2004). Contrast and perceptual distinctiveness. In Bruce Hayes, Robert Kitchner and Donca Steriade (eds.), *Phonetically-Based Phonology*, 232-276. Cambridge: Cambridge University Press.
- Flemming, Edward. (2009). The phonetics of schwa vowels. In Donka Minkova (ed), *Phonological Weakness in English: From Old to Present-Day English*, 78-95. Basingstoke, UK: Palgrave Macmillan.
- Flemming, Edward and Stephanie Johnson. (2007). Rosa's roses: reduced vowels in American English. *Journal of the International Phonetic Association* 37 (1): 83-96.
- Fudge, Erik. (1984). *English Word-Stress*. London: George Allen and Unwin.
- Giegerich, Heinz J. (1992). *English Phonology: An Introduction*. Cambridge: Cambridge University Press.
- Goldsmith, John A. (1976). *Autosegmental Phonology*. Doctoral dissertation, Massachusetts Institute of Technology. Published in 1979, New York: Garland Publishing.
- Goldsmith, John A. (1990). *Autosegmental and Metrical Phonology*. Oxford: Blackwell.

- Goldsmith, John A. (1993). Harmonic phonology. In John A. Goldsmith (ed.), *The Last Phonological Rule: Reflections on Constraints and Derivations*, 21–60. Chicago: University of Chicago Press.
- Goldsmith, John A. (2008). Generative phonology in the late 1940s. *Phonology* 25: 1–23.
- Goldsmith, John A. (2011). The syllable. In John A. Goldsmith, Jason Riggle and Alan Yu (eds.), *The Handbook of Phonological Theory* 2, 162–196. Malden, MA and Oxford: Wiley Blackwell.
- Gussmann, Edmund. (2002). *Phonology: Theory and Analysis*. Cambridge: Cambridge University Press.
- Gussmann, Edmund and Jonathan D. Kaye. (1993). Polish notes from a Dubrovnik café. *SOAS Working Papers in Linguistics and Phonetics* 3: 427-462.
- Hall, Tracy A. (2007). Segmental features. In Paul de Lacy (ed.), *The Cambridge Handbook of Phonology*, 311-334. Cambridge: Cambridge University Press.
- Halle, Morris. (1992). Latvian declension. In Geert Booij and Jaap van der Marle (eds.), *Morphology Yearbook 1991*, 33-47. Dordrecht: Kluwer.
- Halle, Morris. (1995). The Russian declension. In Jennifer Cole and Charles Kisseberth (eds.), *Perspectives in Phonology*, 321-353. Stanford : CSLI.
- Halle, Morris and George N. Clements. (1982). *Problem Book in Phonology: a Workbook for Introductory Courses in Linguistics and in Modern Phonology*. Cambridge, MA: MIT Press.
- Halle, Morris and Karuvannur. P. Mohanan. (1985). The segmental phonology of modern English. *Linguistic Inquiry* 16: 57-116.
- Halle, Morris, Bert Vaux and Andrew Wolfe. (2000). On feature spreading and the representation of place of articulation. *Linguistic Inquiry* 31: 387-444.

- Halle, Morris and Jean-Roger Vergnaud. (1980). Three-dimensional phonology. *Journal of Linguistic Research* 1: 83-105.
- Halle, Morris and Jean-Roger Vergnaud. (1987). *An Essay on Stress*. Cambridge, MA: MIT Press.
- Harris, John. (1989). Towards a lexical analysis of sound change in progress. *Journal of Linguistics* 25: 35-56.
- Harris, John. (1994). *English Sound Structure*. Oxford: Blackwell.
- Harris, John. (1997). Licensing inheritance: an integrated theory of neutralization. *Phonology* 14: 315-370.
- Harris, John. (2004). Release the captive coda: the foot as a domain of phonetic interpretation. In John Local, Richard Ogden and Rosalind A. M. Temple (eds.), *Phonetic Interpretation: Papers in Laboratory Phonology* 6, 119-132. Cambridge: Cambridge University Press.
- Harris, John. (2005). Vowel reduction as information loss. In Philip Carr, Jacques Durand and Colin J. Ewen (eds.), *Headhood, Elements, Specification and Contrastivity*, 119-132. Amsterdam and Philadelphia: John Benjamins.
- Harris, John. (2006). The phonology of being understood: further arguments against sonority. *Lingua* 116: 1483-1494.
- Harris, John. (2007). Representation. In Paul de Lacy (ed.), *The Cambridge Handbook of Phonology*, 119-138. Cambridge: Cambridge University Press.
- Harris, John. (2011). Deletion. In Marc van Oostendorp, Colin J. Ewen, Beth Hume and Keren Rice (eds.), *The Blackwell Companion to Phonology III*, 1597-1621. Oxford: Wiley.

- Harris, John and Edmund Gussmann. (1998). Final codas: why the west was wrong. In Eugeniusz Cyran (ed.), *Structure and Interpretation: Studies in Phonology*, 139-162. Lublin: Folium.
- Harris, John and Edmund Gussmann. (2002). Word-final onsets. *UCL Working Papers in Linguistics* 14: 1-42.
- Harris, John and Jonathan D. Kaye. (1990). A tale of two cities: London glottalling and New York City tapping. *The Linguistic Review* 7: 251-274.
- Harris, John and Geoff Lindsey. (1995). The elements of phonological representation. In Jacques Durand and Francis Katamba (eds.), *Frontiers of Phonology: Atoms, Structures, Derivations*, 34-79. Harlow, Essex: Longman.
- Harris, John and Geoff Lindsey. (2000). Vowel patterns in mind and sound. In Noel Burton-Roberts, Philip Carr and Gerry Docherty (eds.), *Phonological Knowledge: Conceptual and Empirical Issues*, 185-205. Oxford: Oxford University Press.
- Harris, John and Eno-Abasi Urua. (2001). Lenition degrades information: consonant allophony in Ibibio. *Speech, Hearing and Language: Work in Progress* 13: 72-105.
- Hartmann, Jutta M., Veronika Hegedüs and Henk van Riemsdijk. (2008). Introduction. In Jutta M. Hartmann, Veronika Hegedüs and Henk van Riemsdijk (eds.), *Sounds of Silence: Empty Elements in Syntax and Phonology*, 1-20. Amsterdam: Elsevier.
- Hawkins, Peter. (1984). *Introducing Phonology*. London: Hutchinson.
- Hayes, Bruce. (1986). Inalterability in CV phonology. *Language* 62: 321-351.
- Hayes, Bruce. (1990). Diphthongization and coindexing. *Phonology* 7: 31-71.
- Hayes, Bruce. (1995). *Metrical Stress Theory: Principles and Case Studies*. Chicago: University of Chicago Press.

- Hayes, Bruce and Donca Steriade. (2004). Introduction: the phonetic bases of phonological markedness. In Bruce Hayes, Robert Kirchner and Donca Steriade (eds.), *Phonetically Based Phonology*, 1-33. Cambridge: Cambridge University Press.
- Hulst, Harry van der. (1988). The geometry of vowel features. In Harry van der Hulst and Norval Smith (eds.), *Features, Segmental Structure and Harmony Processes*, 77-126. Dordrecht: Foris.
- Hulst, Harry van der. (1989). Atoms of segmental structure: components, gestures and dependency. *Phonology* 6: 439-477.
- Hulst, Harry van der. (1994). Radical CV phonology: the locational gesture. *UCL Working Papers in Linguistics* 6: 439-478.
- Hulst, Harry van der. and Noval Smith. (1988). *Features, Segmental Structure and Harmony Processes, Part I, II*. Dordrecht: Foris.
- Hyman, Larry M. (1975). *Phonology: Theory and Analysis*. New York: Holt, Rinehart and Winston.
- Hyman, Larry M. (1985). *A Theory of Phonological Weight*. Dordrecht: Foris.
- Ito, Junko. (1986). *Syllable Theory in Prosodic Phonology*. Doctoral dissertation, Amherst, University of Massachusetts. Published in 1988, New York: Garland.
- Jakobson, Roman C., Gunnar M. Fant and Morris Halle. (1952). *Preliminaries to Speech Analysis: The Distinctive Features and their Correlates*. Technical Report No. 13. Acoustics Laboratory, Massachusetts Institute of Technology. Published in 1967, 7th edition, Cambridge, MA: MIT press.
- Jakobson, Roman C. and Morris Halle. (1956). *Fundamentals of Language*. The Hague: Mouton.

- Jensen, John T. (1991). Vowel laxing and vowel reduction in English. *Paper read at the Annual Meeting of the Canadian Linguistics Association, Toronto Working Papers in Linguistics*, 133-144. (May, 1992)
- Jensen, John T. (1993). *English Phonology*. Amsterdam: John Benjamins.
- Jespersen, Otto. (1909). *A Modern English Grammar on Historical principles I: Sounds and Spellings*. London: George Allen and Unwin. Reprinted in 1961.
- Katamba, Francis. (1984). A nonlinear analysis of vowel harmony in Luganda. *Journal of Linguistics* 20: 257-275.
- Kaye, Jonathan D. (1989). *Phonology: A Cognitive View*. New Jersey: Lawrence Erlbaum Associates.
- Kaye, Jonathan D. (1990a). Government in phonology: the case of Moroccan Arabic. *The Linguistic Review* 6: 131-159.
- Kaye, Jonathan D. (1990b). 'Coda' licensing. *Phonology* 7: 301-330.
- Kaye, Jonathan D. (1992). Do you believe in magic?: the story of s+C sequences. *SOAS Working Papers in Linguistics and Phonetics* 2: 293–314.
- Kaye, Jonathan D. (1995). Derivations and interfaces. In Jacques Durand and Francis Katamba (eds.), *Frontiers of Phonology: Atoms, Structures, Derivations*, 289-332. Harlow, Essex: Longman.
- Kaye, Jonathan D., Jean Lowenstamm and Jean-Roger Vergnaud. (1985). The internal structure of phonological elements: a theory of charm and government. *Phonology Yearbook* 2: 305-328.
- Kaye, Jonathan D., Jean Lowenstamm and Jean-Roger Vergnaud. (1990). Constituent structure and government in phonology. *Phonology* 7: 193-231.
- Kaye, Jonathan D. and Murkus A. Pöchtrager. (2013). GP 2.0. *SOAS Working Papers in Linguistics* 16: 51–64.

- Keating, Patricia A. (1988). Underspecification in phonetics. *Phonology* 5: 275-292.
- Kenstowicz, Michael. (1994). *Phonology in Generative Grammar*. Oxford: Blackwell.
- Kenstowicz, Michael. (2003). Saliency and similarity in loanword adaptation: a case study from Fijian. Ms. Massachusetts Institute of Technology (ROA).
- Kenstowicz, Michael. (2007). Saliency and similarity in loanword adaptation: a case study from Fijian. *Language Sciences* 29: 316-340.
- Kiparsky, Paul. (1982). From cyclic phonology to lexical phonology. In Harry van der Hulst and Noval Smith (eds.), *The Structure of Phonological Representations* 1, 131-175. Dordrecht: Foris.
- Kiparsky, Paul. (1985). Some consequences of lexical phonology. *Phonology Yearbook* 2: 85-138.
- Kiparsky, Paul. (1995). The phonological basis of sound change. In John A. Goldsmith (ed.), *The Handbook of Phonological Theory*, 640-670. Oxford: Blackwell.
- Kiparsky, Paul. (2008). Universals constrain change: change results in typological generalizations. In Jeff Good (ed.), *Linguistic Universals and Language Change*, 23-53. Oxford: Oxford University Press.
- Kumagai, Gakuji. (2014). Suprasegmental nativization of English loanwords into Fijian. *Phonological Studies* 17: 19-26.
- Kural, Murat. (2005). Tree traversal and word order. *Linguistic Inquiry* 36: 367-387.
- Kurath, Hans. (1964). *A Phonology and Prosody of Modern English*. The University of Michigan Press.
- Labov, William. (1994). *Principles of Linguistic Change Vol.1: Internal Factors*. Oxford: Blackwell.
- Ladefoged, Peter. (1993). *A Course in Phonetics*. 3rd edition. Fort Worth: Harcourt Brace.

- Ladefoged, Peter. (1997). Linguistic phonetic descriptions. In William Hardcastle and John Laver (eds.), *The Handbook of Phonetic Sciences*, 589-618. Oxford: Blackwell.
- Ladefoged, Peter and Ian Maddieson. (1996). *The Sounds of the World's Languages*. Oxford: Blackwell.
- Lass, Roger. (1984). *Phonology: an Introduction to Basic Concepts*. Cambridge: Cambridge University Press.
- Leben, William. (1973). *Suprasegmental Phonology*. Doctoral dissertation, Massachusetts Institute of Technology.
- Libermann, Mark and Alan Prince. (1977). On stress and linguistic rhythm. *Linguistic Inquiry* 8: 249–336.
- Lindau, Mona. (1978). Vowel features. *Language* 54: 541-63.
- Lindblom, Björn E. (1990). Explaining phonetic variation: a sketch of the H&H theory. In William J. Hardcastle and Alain Marchal (eds), *Speech Production and Speech Modeling*, 403-439. Dordrecht: Kluwer.
- Lindsey, Geoff. (1990). Quantity and quality in British and American vowel systems. In Susan Ramsaran (ed.), *Studies in the Pronunciation of English: a Commemorative Volume in Honour of A.C. Gimson*, 106-118. London: Routledge.
- Lindsey, Geoff and John Harris. (1990). Phonetic interpretation in generative grammar. *UCL Working Papers in Linguistics* 2: 355-369.
- Lowenstamm, Jean. (1981). On the maximal cluster approach to syllable structure. *Linguistic Inquiry* 12: 575-604.
- Lowenstamm, Jean. (1996). CV as the only syllable type. In Jacques Durand and Bernard Laks (eds.), *Current Trends in Phonology: Models and Methods*, 419-441. Salford, Manchester: European Studies Research Institute, University of Salford Publications.
- Maddieson, Ian. (1984). *Patterns of Sounds*. Cambridge: Cambridge University Press.

- McCarthy, John J. (1988). Feature geometry and dependency: a review. *Phonetica* 45: 84–108.
- Mwihaki, Alice. (2001). Consonant–vowel harmony: evidence from the phonotactics of loanword adaptation. *Poznan Studies in Contemporary Linguistics* 37: 139–145.
- Nasukawa, Kuniya. (1995). Nasality and harmony in Gokana. *UCL Working Papers in Linguistics* 7: 511-533.
- Nasukawa, Kuniya. (1998). An integrated approach to nasality and voicing. In Eugeniusz Cyran (ed.), *Structure and Interpretation: Studies in Phonology*, 205-225. Lublin: Folium.
- Nasukawa, Kuniya. (1999). Prenasalisation and melodic complexity. *UCL Working Papers in Linguistics* 11: 207-224.
- Nasukawa, Kuniya. (2005a). Nihongo-doshi-gokan no goi-hyoji to doshi-kussetu ni okeru aritugi-ketugo [The lexical representation of Japanese verb stems and dovetailing in verb inflexion]. In Tsuyoshi Oishi, Tetsuo Nishihara and Yoji Toyoshima (eds.), *Gendai Keitairon no Choryu* [Current Trends in Morphology], 239-258. Tokyo: Kuroshio.
- Nasukawa, Kuniya. (2005b). *A Unified Approach to Nasality and Voicing*. Berlin: Mouton de Gruyter.
- Nasukawa, Kuniya. (2010a). No consonant-final stems in Japanese verb morphology. *Lingua* 120: 2336-2352.
- Nasukawa, Kuniya. (2010b). Prosodic affiliation of NC sequences in Lungu (Cilungu). In Karsten Legère and Christina Thornell (eds.), *Bantu Languages: Analysis, Description and Theory*, 191-207. Köln: Rüdiger Köppe Verlag.

- Nasukawa, Kuniya. (2010c). Eliminating precedence relations from phonology. *Universal Grammar and Individual Languages, The 2010 Seoul International Conference on Linguistics (SICOL-2010)*. Seoul, Korea: Hankookmunhwasa.
- Nasukawa, Kuniya. (2011). Representing phonology without precedence relations. *English Linguistics* 28: 278-300.
- Nasukawa, Kuniya. (2012). Recursion in intra-morphemic phonology. *Paper presented at Workshop: Language and the Brain*. The 9th International Conference on the Evolution of Language (Evolang IX), Kyoto, Japan (13 March 2012).
- Nasukawa, Kuniya. (2014). Features and recursive structure. In Martin Krämer, Sandra-Iulia Ronai and Peter Svenonius (eds.), *Nordlyd* 41 (1): *Special Issue on Features*, 1-19.
- Nasukawa, Kuniya. (2015a). Recursion in the lexical structure of morphemes. In Marc van Oostendorp and Henk van Riemsdijk (eds.), *Representing Structure in Phonology and Syntax*, 211-238. Berlin and Boston: Mouton de Gruyter.
- Nasukawa, Kuniya. (2015b). A precedence-free approach to palatalisation and de-palatalisation in Japanese. Ms. Tohoku Gakuin University.
- Nasukawa, Kuniya and Phillip Backley. (2005a). Dependency relations in element theory: markedness and complexity. In Nancy Chongo Kula and Jeroen van de Weijer (eds.), *Proceedings of the Government Phonology Workshop: Special issue of Leiden Papers in Linguistics* 2 (4), 77-93. ULCL, Leiden University.
- Nasukawa, Kuniya and Phillip Backley. (2005b). Consonantal representations in element theory: markedness and complexity. *A Minimalist View of Components in Generative Grammar* 1: 117-136. Tohoku Gakuin University.
- Nasukawa, Kuniya and Phillip Backley. (2008). Affrication as a performance device. *Phonological Studies* 11: 35-46.

- Nasukawa, Kuniya and Phillip Backley. (2011). The internal structure of ‘r’ in Japanese. *Phonological Studies* 14: 27-34.
- Nasukawa, Kuniya and Phillip Backley. (2015). Heads and complements in phonology: a case of role reversal? *Phonological Studies* 18: 67-74.
- Nespor, Marina and Vogel Irene. (1986). *Prosodic Phonology*. Dordrecht: Foris.
- Noske, Roland G. (1982). Syllabification and syllable changing rules in French. In Harry van der Hulst and Noval Smith (eds.), *The Structure of Phonological Representations* 2, 257-310. Dordrecht: Foris.
- Oishi, Masayuki and Kuniya Nasukawa. (2011). *Introduction to English Linguistics*. 2nd edition. Tohoku Gakuin University.
- Onuma, Hitomi. (2010). The representation of schwa in English. M.A. dissertation, Tohoku Gakuin University.
- Onuma, Hitomi. (2011). English schwa in Particle Phonology. *Tohoku* 44: 15-38. Tohoku Gakuin University.
- Oostendorp, Marc van. (2003). Schwa in phonological theory. In Lisa Cheng and Rint Sybesma (eds.), *The Second Glot International State-of-the-Article Book*, 431-461. Berlin and New York: Mouton de Gruyter.
- Park, Whaja. (1987). *Western Loan-words in Japanese*. Stockholm: Stockholm University.
- Pettersson, Thore and Sidney Wood. (1987). Vowel reduction in Bulgarian and its implications for theories of vowel production: a review of the problem. *Folia Linguistica* XXI/2-4: 262-279.
- Piggott, Glynne. (1992). Variability in feature dependency: the case of nasal harmony. *Natural Language and Linguistic Theory* 10: 33-77.

- Pöchtrager, Markus A. (2006). *The Structure of Length*. Doctoral dissertation, University of Vienna.
- Pöchtrager, Markus A. (2015). Vowel reduction: sawing off the branch you're sitting on. *Paper presented at the 23rd Manchester Phonology Meeting*. University of Manchester, UK (28 May 2015).
- Prince, Alan and Paul Smolensky. (1993). *Optimality Theory: Constraint Interaction in Generative Grammar*. Technical Report CU-CS-696-93, Department of Computer Science, University of Colorado at Boulder, and Technical Report TR-2, Rutgers Center for Cognitive Science, Rutgers University, New Brunswick, N.J. April.
- Pulleyblank, Douglas. (1988). Vocalic underspecification in Yoruba. *Linguistic Inquiry* 19. 233-270.
- Pulleyblank, Douglas. (1998). *Yoruba Vowel Patterns: Deriving Asymmetries by the Tension between Opposing Constraints*. Ms. University of British Columbia.
- Rennison, John R. (1986). On tridirectional feature systems for vowels. In Jacques Durand (ed.), *Dependency and Non-linear Phonology*, 281-303. London: Croom Helm.
- Rennison, John R. (1987). Vowel harmony and tridirectional features. *Folia Linguistica* XXI/2-4: 337-54.
- Rennison, John R. (1991). On the elements of phonological representations: the evidence from vowel systems and vowel processes. *Folia Linguistica* XXIV: 175-244.
- Rocca, Iggy. (1994). *Generative Phonology*. London: Routledge.
- Roca, Iggy and Wyn Johnson. (1999). *A Course in Phonology*. Oxford: Blackwell.
- Sagey, Elizabeth. (1986). *The Representation of Features and Relations in Nonlinear Phonology*. Doctoral dissertation, Cambridge, Massachusetts Institute of Technology.

- Sainz, Susana. (1988). A noncyclic analysis of English word stress. *Working Papers of the Cornell Phonetics Laboratory* 3: 1-82.
- Schane, Sanford A. (1973). [back] and [round]. In Stephen R. Anderson and Paul Kiparsky (eds.), *A Festschrift for Morris Halle*, 178-84. Cambridge, MA: MIT Press.
- Schane, Sanford A. (1984). The fundamentals of particle phonology. *Phonology Yearbook* 1: 129-155.
- Schane, Sanford A. (1995). Diphthongization in particle phonology. In John A. Goldsmith (ed.), *The Handbook of Phonological Theory*, *Blackwell Handbooks in Linguistics*, 586–608. Oxford: Blackwell.
- Schane, Sanford A. (2005). The aperture particle [a]: its role and functions. In Philip Carr, Jacques Durand and Colin J. Ewen (eds.), *Headhood, Elements, Specification and Contrastivity*, 313-338. Amsterdam and Philadelphia: John Benjamins.
- Scheer, Tobias. (1998). A unified model of proper government. *The Linguistic Review* 15: 41-67.
- Scheer, Tobias. (2004). *A Lateral Theory of Phonology Vol. 1: What is CVCV, and Why Should It Be?* Berlin: Mouton de Gruyter.
- Scheer, Tobias. (2008). Spell out your sister! In Natasha Abner and Jason Bishop (eds.), *Proceedings of the 27th West Coast Conference on Formal Linguistics*, 379-387. Somerville: Cascadilla.
- Scheer, Tobias. (2011). *A Guide to Morphosyntax-Phonology Interface Theories: How Extra-Phonological Information is Treated in Phonology since Trubetzkoy's Grenzsignale*. Berlin: Mouton de Gruyter.

- Schütz, Albert J. (1978). English loanwords in Fijian. In Schütz, Albert (ed.), *Fijian Language Studies: Borrowing and Pidginization, Bulletin of Fiji Museum* No.4, 1-50. Suva, Fiji: Fiji Museum.
- Schütz, Albert J. (1985). *The Fijian Language*. Honolulu: University of Hawaii Press.
- Scobbie, James M. (1997). *Autosegmental Representation in a Declarative Constraint-Based Framework*. New York: Garland Press.
- Selkirk, Elisabeth. (1982). The syllable. In Harry van der Hulst and Noval Smith (eds.), *The Structure of Phonological Representations 2*, 337-383. Dordrecht: Foris.
- Silverman, Daniel. (2011). Schwa. In Marc van Oostendorp, Colin J. Ewen, Beth Hume, and Keren Rice (eds.), *The Blackwell Companion to Phonology I*, 628-642. Malden, MA and Oxford: Wiley Blackwell.
- Spencer, Andrew. (1996). *Phonology: Theory and Description*. Oxford: Blackwell.
- Stemberger, Joseph Paul. (1991). Radical underspecification in language production. *Phonology* 8: 73-112.
- Steriade, Donca. (1995). Underspecification and markedness. In John A. Goldsmith (ed.), *The Handbook of Phonological Theory*, 114-174. Cambridge, MA and Oxford: Blackwell.
- Stevens, Kenneth N. (1989). On the quantal nature of speech. *Journal of Phonetics* 17: 3-45.
- Stevens, Kenneth N. (2000). Diverse acoustic cues at consonantal landmarks. *Phonetica* 57: 139-151.
- Takahashi, Toyomi. (2004). *Syllable Theory without Syllables*. Doctoral dissertation, University College London, University of London.
- Topintzi, Nina. (2010). *Onsets: Suprasegmental and Prosodic Behaviour*. Cambridge: Cambridge University Press.

- Tranel, Bernard. (1981). *Concreteness in Generative Phonology: Evidence from French*. Berkeley, CA: University of California Press.
- Uffmann, Christian. (2006). Epenthetic vowel quality in loanwords: empirical and formal issues. *Lingua* 116: 1079 – 1111.
- Vago, Robert M. (1988). Underspecification in the height harmony system of Pasiego. *Phonology* 5: 343-362.
- Vergnaud, Jean-Roger. (1982). *Dépendances et Niveaux de Représentation en Syntaxe*. Doctoral dissertation, Université Paris 7.
- Wells, John C. (1982). *Accents of English 2: the British Isles*. Cambridge: Cambridge University Press.
- Wells, John C. (2008). *Longman Pronunciation Dictionary*. 3rd edition. London: Longman.
- Wiese, Richard. (1996). *The Phonology of German*. Oxford: Clarendon Press.
- Yip, Moira. (1988). The obligatory contour principle and phonological rules: a loss of identity. *Linguistic Inquiry* 19: 65-100.